

# oventrop

Innovation + Quality

Valves, controls + systems

Flow, pressure and temperature balancing

Product range

Awards:

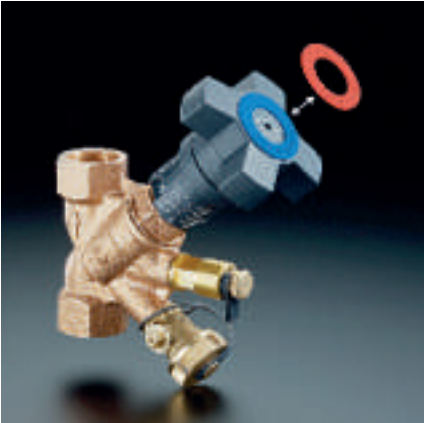

| Content  | Page |
|--|------|
| <b>Flow, pressure and temperature balancing</b>  |      |
| Necessity of hydronic balancing  | 3    |
| Mode of operation of Oventrop valves and controls  | 4    |
| Oventrop double regulating and commissioning valves<br>Ranges of control and performance   | 6    |
| Oventrop regulators<br>Ranges of control and performance   | 8    |
| Oventrop regulating valve with integrated<br>metering station<br>Ranges of control and performance   | 12   |
| Oventrop metering stations<br>Ranges of performance  | 13   |
| Hydronic balancing according to a<br>specifying engineer's calculation   | 14   |
| Hydronic balancing on site<br>"OV-DMPC" / "OV-DMC 2"   | 16   |
| Measuring methods<br>Differential pressure transmitter<br>"OV-Connect"   | 17   |
| Application in heating and cooling systems   | 18   |
| Examples in chilled and radiant ceiling systems  | 19   |
| <b>Description of the products</b>   |      |
| Valves for hydronic balancing "Hycococon"  | 22   |
| Double regulating and commissioning valve<br>"Hycococon VTZ"   | 23   |
| Double regulating and commissioning valve<br>"Hydrocontrol"  | 24   |
| Double regulating and commissioning valves<br>"Hydrocontrol AFC", "Hydrocontrol VPR",<br>"Hydrocontrol VTR", "Hydrocontrol VFC",<br>"Hydrocontrol VFN", "Hydrocontrol VFR" and<br>"Hydrocontrol VGC" | 25   |
| Differential pressure regulators<br>"Hycococon DTZ", "Hydromat DTR" and "Hydromat DFC"   | 26   |
| Flow regulators<br>"Hydromat DTR", "Cocon QTZ" and "Cocon QFC"   | 27   |
| Pressure independent control valve with<br>automatic flow control "Cocon QTZ"  | 28   |
| Regulating valve "Cocon 2TZ"   | 29   |
| Three-way valves "Tri-D TB/TR", "Tri-D plus TB" and<br>"Tri-M TR"  |      |
| Four-port valve "Tri-M plus TR"  |      |
| Regulating valve with reversed closing function  | 30   |
| Metering stations  | 31   |
| Actuators, room thermostats  | 32   |
| Combination possibilities of valves and actuators  | 33   |
| Working supports /Service  | 36   |

### Why balance?

Hydronic balancing of heating and cooling systems is necessary to avoid the following problems:

- some rooms almost never achieve the desired room temperature or are not cooled sufficiently. This problem especially arises in case of influence of other heat sources
- after changing over from low temperature to heating operation, parts of the system are only heated after a long time
- fluctuating room temperatures especially arising during low demand periods
- high energy consumption although the required room temperature regulator is installed

### Distribution of flow

The main reason for these problems is that incorrect flows are available in the various circuits. If this is the case, the problem may be solved by installing double regulating and commissioning valves, differential pressure regulators or flow regulators in the corresponding pipes. The course of pressure in a circuit makes clear why this occurs.

The illustration shows that the pump has to produce a differential pressure of at least  $\Delta p_{\text{total}}$  to guarantee a sufficient supply to appliance 4. This will, however, inevitably result in an excessive differential pressure at the appliances 1 to 3. This too high a differential pressure will cause an increased flow at these appliances and thus to an increased energy consumption. To remedy this, double regulating and commissioning valves are installed. The excessive differential pressure is now absorbed by the double regulating and commissioning valves. The desired flow rate may be controlled and set. To be able to control appliance 4 as well, it is recommended to install a double regulating and commissioning valve here, too. The correct supply of each appliance is now guaranteed.

### Energy saving

Wrong flow rates in the various circuits lead to an increased energy consumption. On the one hand, a higher pump capacity must be provided to guarantee a sufficient supply of each appliance and on the other hand appliances being installed at a favorable hydronic position are then oversupplied. This will result in an increased room temperature or, in cooling systems, in too low a room temperature. If the average temperature in a building exceeds the nominal value by  $1^\circ\text{C}$ , the energy consumption is increased by 6–10 %.

In cooling systems, temperatures being  $1^\circ\text{C}$  too low will result in an increase in energy consumption of about 15 %.

Installations, in which the hydronic balancing was not carried out, have to start the heating operation earlier in order to achieve the desired temperature in time.

### How to avoid noises at the TRVs

If the installation is a two pipe installation, not only the design demand but also the periods of low demand have to be considered. The differential pressure at the TRVs has to be limited to approximately 200 mbar. If this value is not exceeded, the thermostatic radiator valves normally do not produce any flow or whistling noises. This condition is met by installing differential pressure regulators in the corresponding circuits.

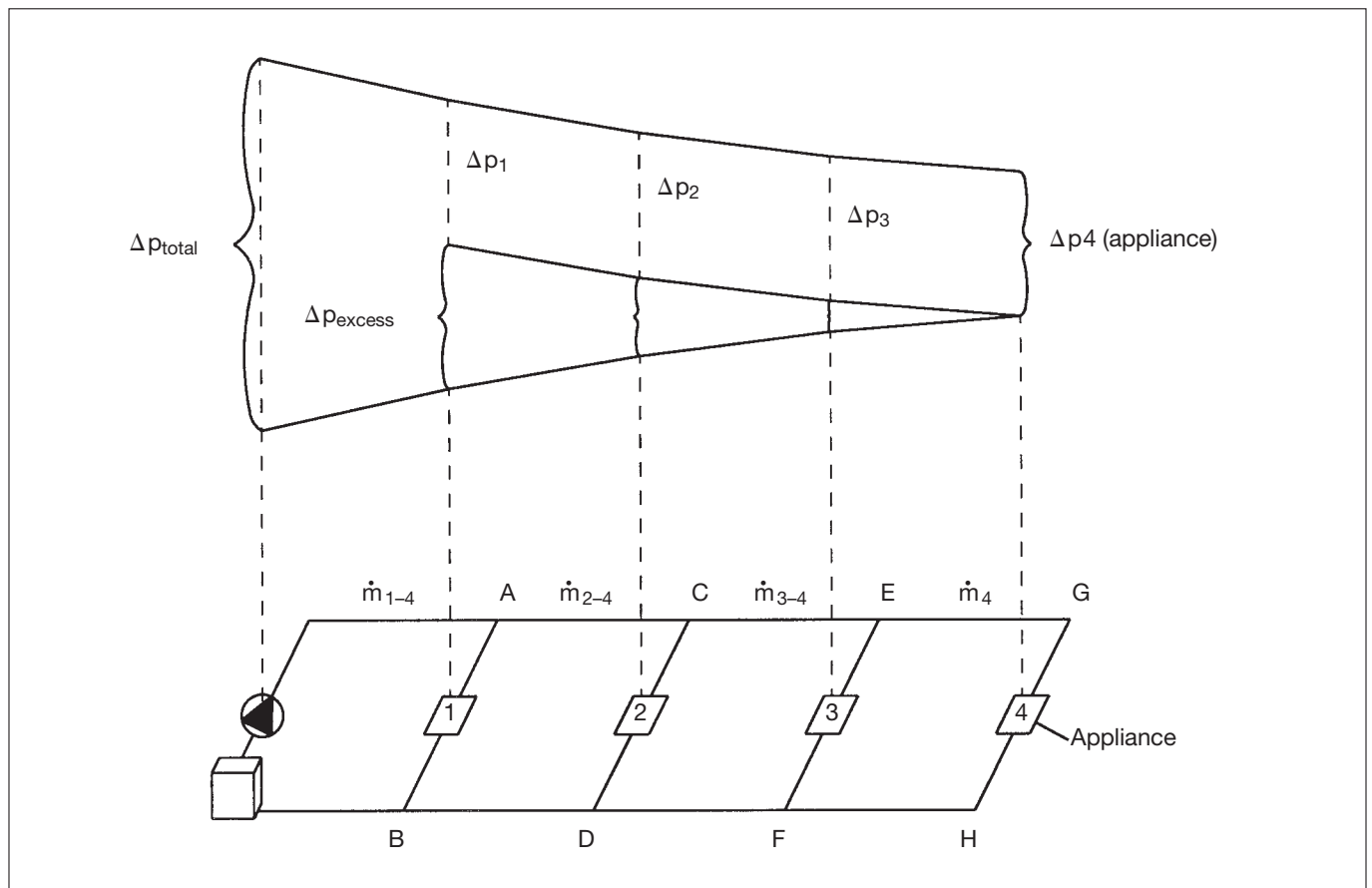

Course of pressure in a circuit

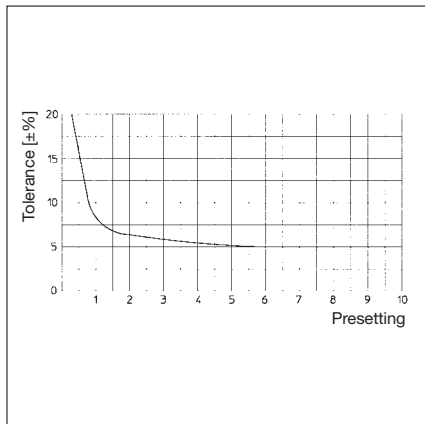

1

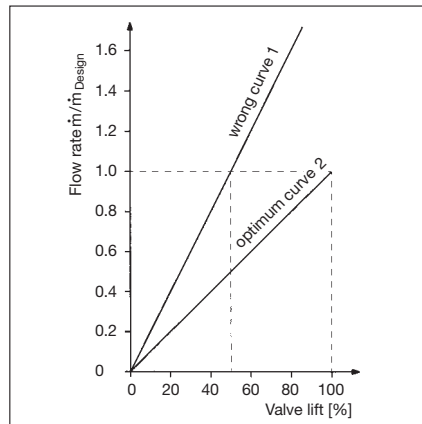

2

### Theoretical view

In order to explain the influence of double regulating and commissioning valves, flow and differential pressure regulators on the hydronic conditions in the corresponding circuits, their mode of operation in principal is illustrated on this page, only with the valves required to this.

### 1 Design of double regulating and commissioning valves

In order to regulate flow as accurately as possible, the correct design is very important. If the presetting values are too low, the flow tolerances will be high. The quality of regulation falls off and the energy consumption increases. The chart makes clear that low presetting values ( $< 1$  for "Hydrocontrol") will result in high tolerances and should therefore be avoided (see example 1 page 14).

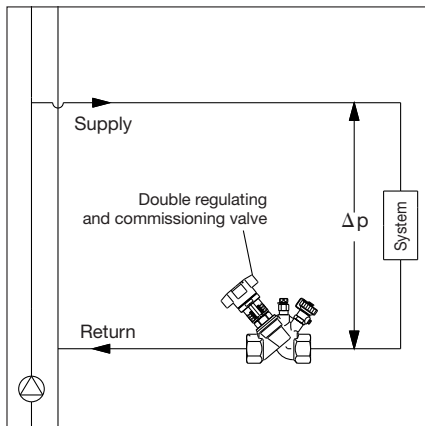

3

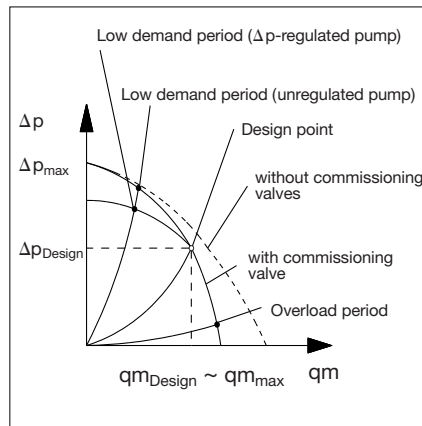

4

### 2 Design of flow and differential pressure regulators

Curve 1 shows a regulating valve being sized incorrectly. Only 50 % of the valve lift is used. Curve 2, however, shows a regulating valve which is designed the best possible. The desired flow is achieved at the maximum valve lift. Stability of the regulating circuit and regulation are improved. The valves thus have to be chosen with care. If the chosen dimensions are too small, the flow rates are not reached and if the chosen dimensions are too high, the results of balancing will be ineffective.

### 3 and 4 Double regulating and commissioning valves

The characteristic lines of a circuit with and without double regulating and commissioning valve as well as the shifting of the characteristic lines caused by the influence of a differential pressure regulated pump are illustrated here. It can be seen that in the design flow in the circuit is reduced by using double regulating and commissioning valves, i.e. the flow in each circuit can be regulated by carrying out presetting. If the installation is overloaded, e.g. by completely opened radiator valves, the differential pressure in the circuit is only increased slightly. The supply of the other circuits is still guaranteed ( $q_{m\_Design} \sim q_{m\_max}$ ). During periods of low demand, i.e. with  $\Delta p$  increasing via the installation, the double regulating and commissioning valve only has a slight effect on the characteristic line of the circuit. Excess differential pressure can be reduced with the help of a  $\Delta p$  regulated pump.

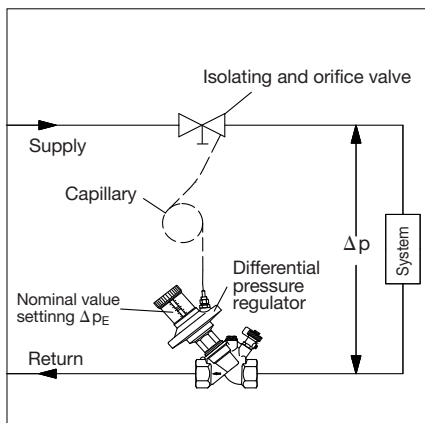

5

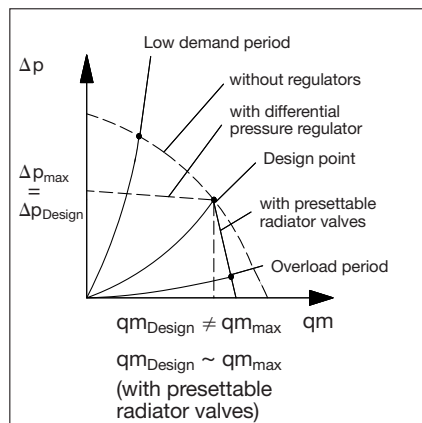

6

### 5 and 6 Differential pressure regulators

The characteristic lines of a circuit with and without differential pressure regulator are illustrated here. It becomes clear that the differential pressure may only slightly exceed the design value during periods of low demand, i.e. thermostatic radiator valves are protected against an inadmissible increase of differential pressure even during periods of low demand, provided that the design value does not exceed 200 mbar. In case of overload, the differential pressure regulators only have a slight impact on the course of the characteristic line ( $q_{m\_Design} \neq q_{m\_max}$ ). When using presettable radiator valves, the flow in the circuit is limited in case of overload ( $q_{m\_Design} \sim q_{m\_max}$ ) (see example 2 page 14).

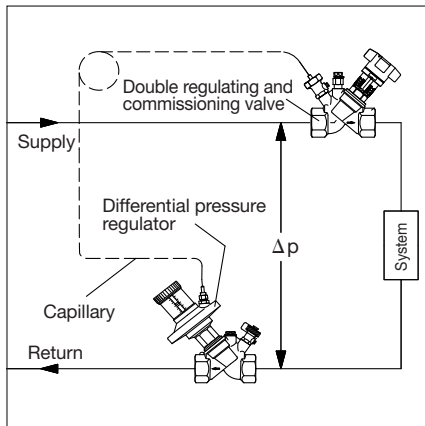

7

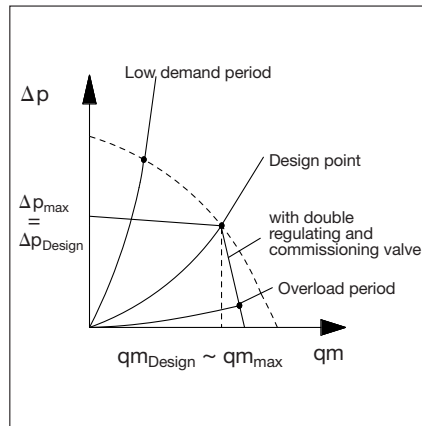

8

### 7 and 8 Combination differential pressure regulator and double regulating and commissioning valve for differential pressure regulation

The characteristic line of a circuit with differential pressure regulator and double regulating and commissioning valve is illustrated here. During periods of low demand, the differential pressure only slightly exceeds the design value. By using the double regulating and commissioning valve in installations without presettable radiator valves, the flow in the circuit is only increased slightly during low demand periods and the supply of all other circuits is thus guaranteed ( $q_{m\text{Design}} \sim q_{m\text{max}}$ ) (see example 3 page 14).

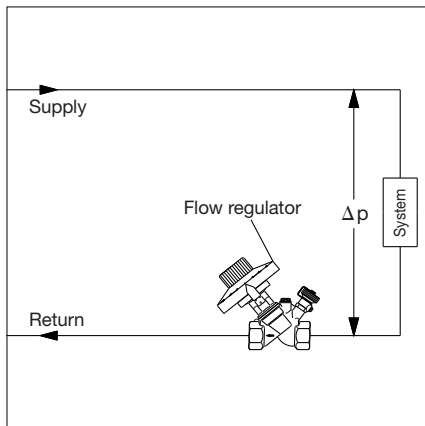

9

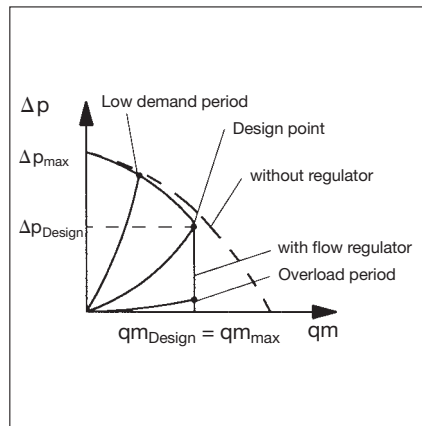

10

### 9 and 10 Flow regulators

The characteristic of a circuit with and without flow regulator are illustrated here. In case of overload, the flow rate only slightly exceeds the design value ( $q_{m\text{Design}} = q_{m\text{max}}$ ) (see example 4 page 15).

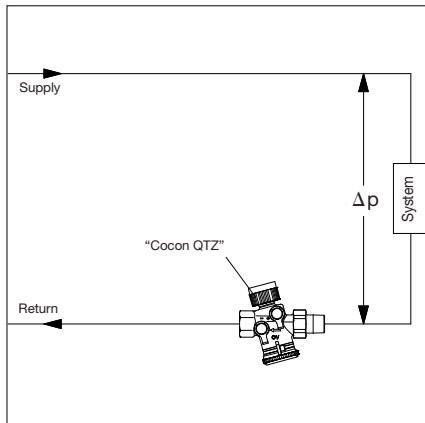

11

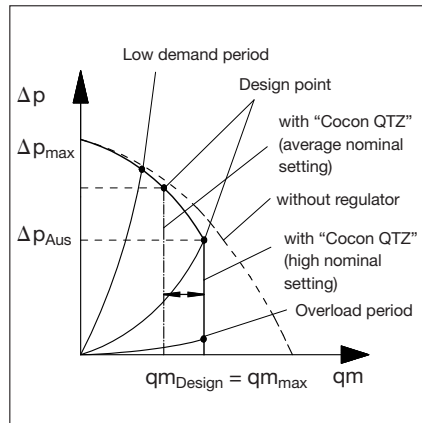

12

### 11 and 12 Pressure independent control valve "Cocon QTZ"

Here, the characteristic lines of a circuit with a pressure independent control valve "Cocon QTZ" are illustrated. In case of overload, the flow is kept at a constant level ( $q_{m\text{Design}} = q_{m\text{max}}$ ). The mode of operation is similar to that of a flow regulator but the pressure independent control valve "Cocon QTZ" can additionally be equipped with an actuator or temperature controller. Not only the flow but also another variable (e. g. the room temperature) can be controlled this way.

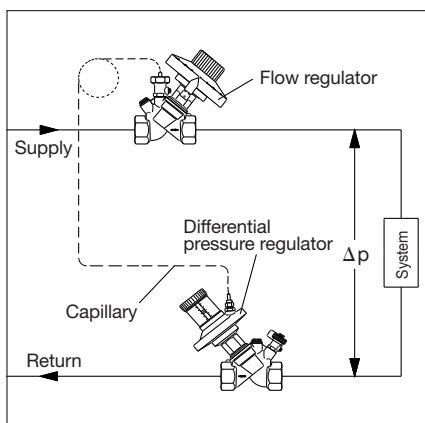

13

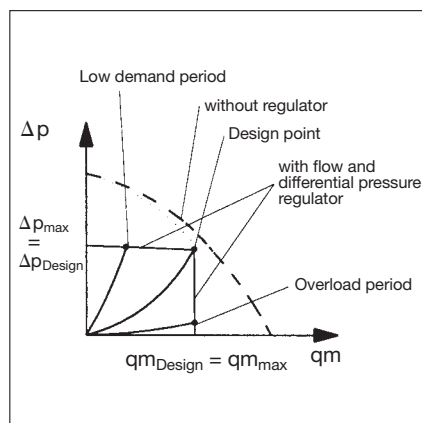

14

### 13 and 14 Combination flow and differential pressure regulator

The characteristic line of a circuit with differential pressure and flow regulator is illustrated here. By installing these two regulators, the flow is limited to the design value in case of overload. During periods of low demand, the differential pressure is limited to the design value, too ( $q_{m\text{Design}} = q_{m\text{max}}$ ,  $\Delta p_{\text{Design}} = \Delta p_{\text{max}}$ ).

The circuit is hydraulically balanced at any point of operation. The supply of the circuits is always guaranteed (see example 6 page 15).

Flow balancing via double regulating and commissioning valves  
Regulation according to pipework calculation or by using a  $\Delta p$  measuring gauge



“Hycocon ATZ/VTZ/ETZ/HTZ”



“Hydrocontrol VTR/ATR”/“Hydrocontrol MTR”/“Aquastrom C”

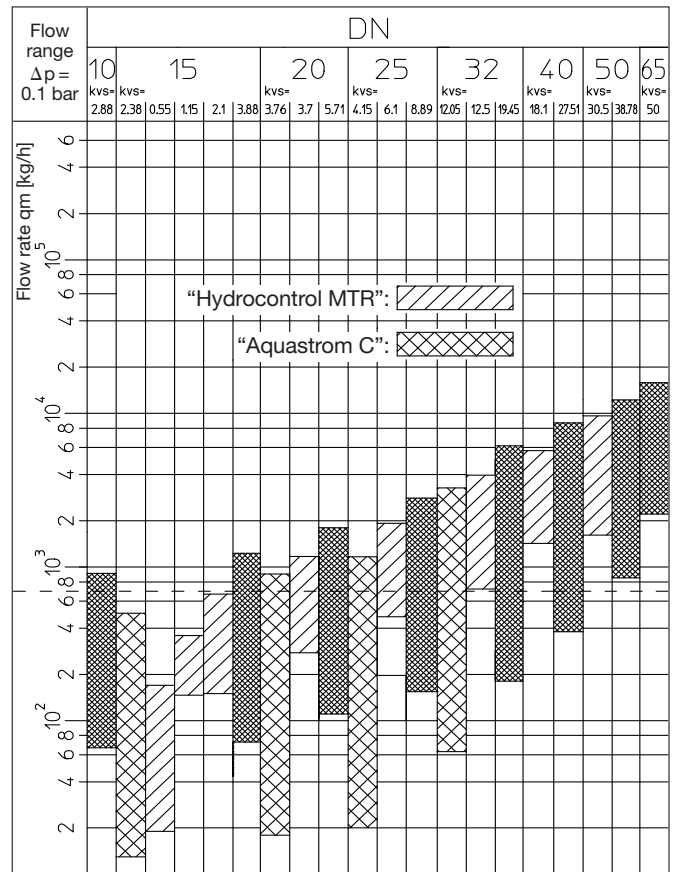
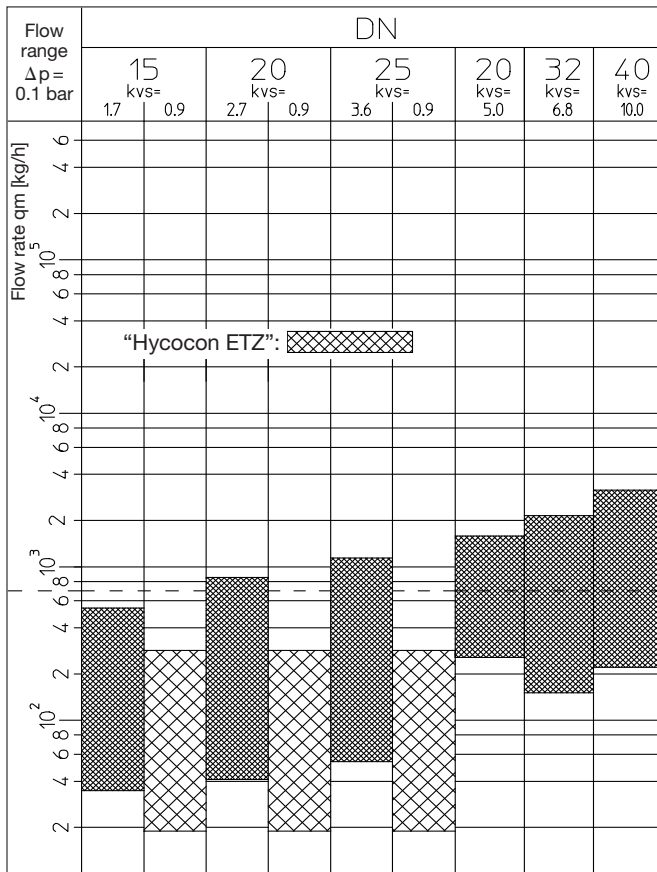

Flow ranges between lowest and highest presetting with  $\Delta p = 0.1$  bar via the double regulating and commissioning valve.  
The below examples only show the valves which are really required for hydronic balancing.

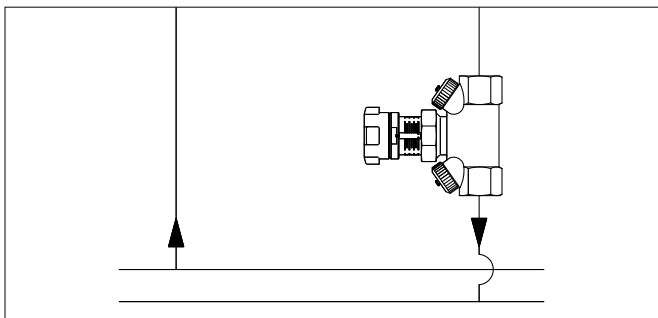

Example: Two pipe heating system for low to medium flow rates.

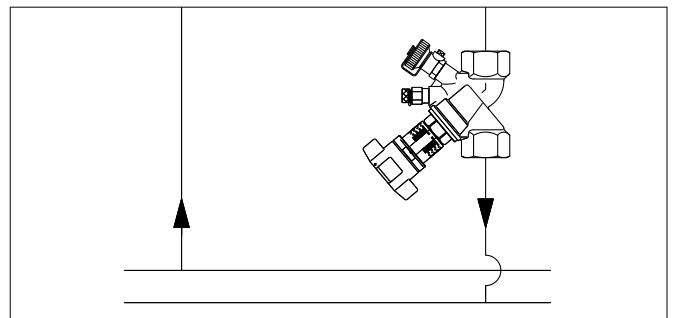

Example: Two pipe heating system for medium to high flow rates.

Conversion of the flow and differential pressure values from a design calculation on the flow rates with  $\Delta p = 0.1$  bar illustrated here:

$$\text{Design calculation: } \Delta p_A, \dot{V}_A$$

$$\text{Conversion: } \dot{V}_{0.1 \text{ bar}} = \dot{V}_A \cdot \sqrt{\frac{0.1 \text{ bar}}{\Delta p_A}}$$



“Hydrocontrol VFC”



“Hydrocontrol VFC/VFR/VFN/VGC”

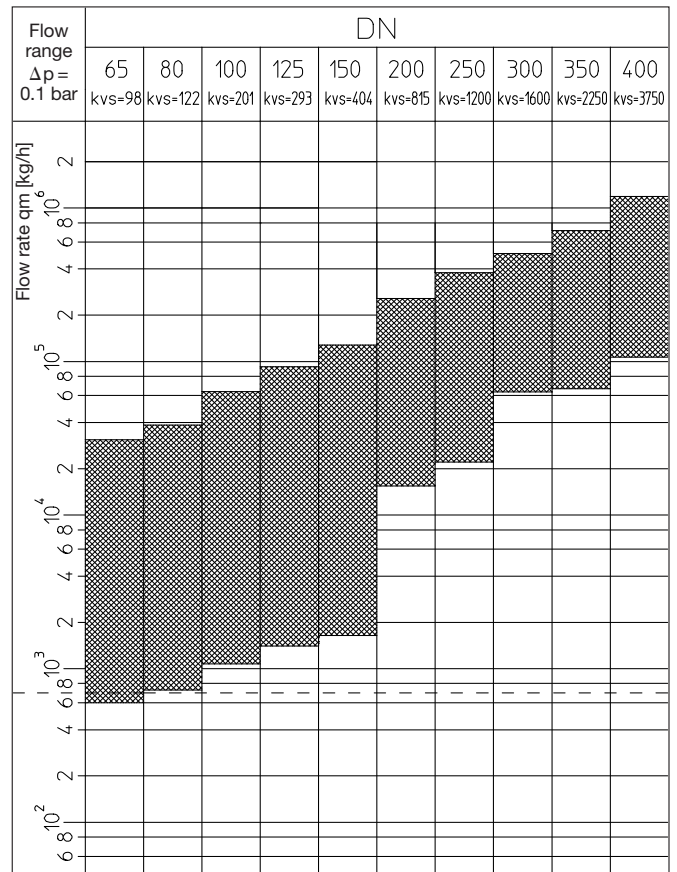
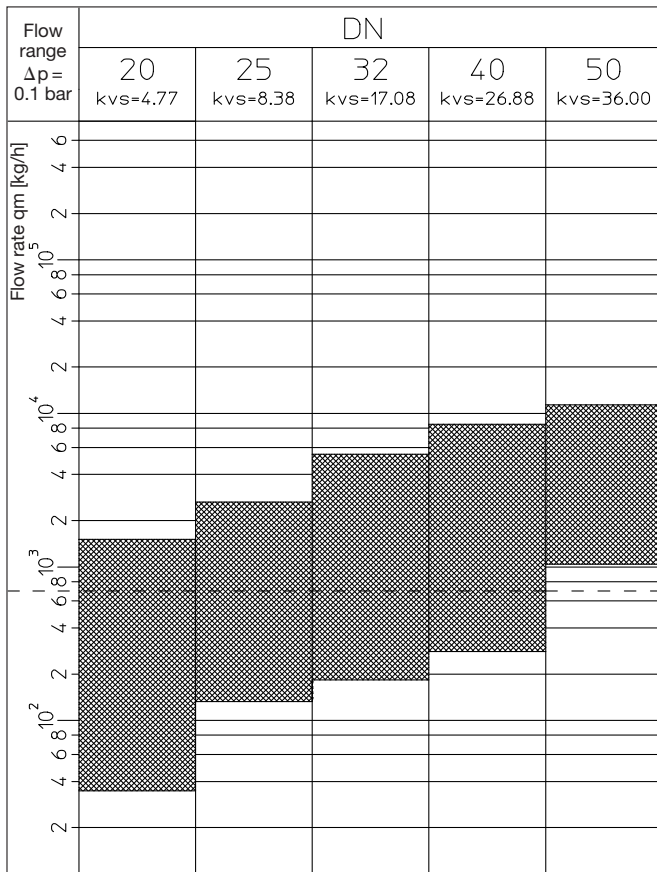

Flow ranges between lowest and highest value of presetting with  $\Delta p = 0.1$  bar via the double regulating and commissioning valve. The below examples only show the valves which are really required for hydronic balancing.

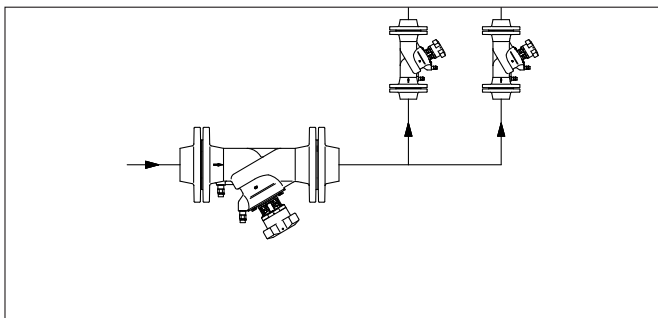

Example: Central heating system with flanged connections.

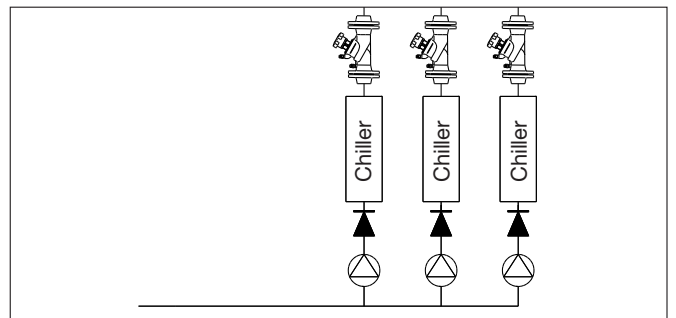

Example: Cooling system with flanged connections.

Example:  $\Delta p_A = 0.15$  bar,  $\dot{V}_A = 850$  kg/h

$$\dot{V}_{0.1 \text{ bar}} = \dot{V}_A \cdot \sqrt{\frac{0.1 \text{ bar}}{0.15 \text{ bar}}} = 694 \text{ kg/h}$$

With the help of the value  $\dot{V}_{0.1 \text{ bar}}$  a preselection, e.g. “Hydrocontrol VTR”, DN 20, can be made (see broken line).

### Differential pressure regulation

### Differential pressure regulation



“Hycococon DTZ” (50–300 mbar) “Hycococon DTZ” (250–600 mbar)



“Hydromat DTR” (50–300 mbar) “Hydromat DTR” (250–700 mbar)

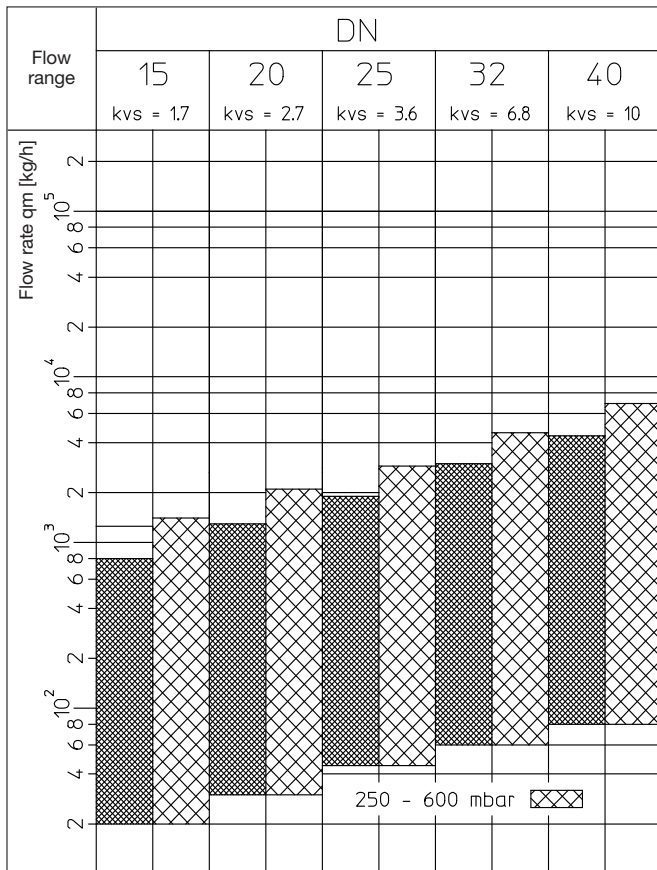

Flow ranges of the differential pressure regulator “Hycococon DTZ” for adjustable differential pressures in the circuits 50–300 mbar or 250–600 mbar

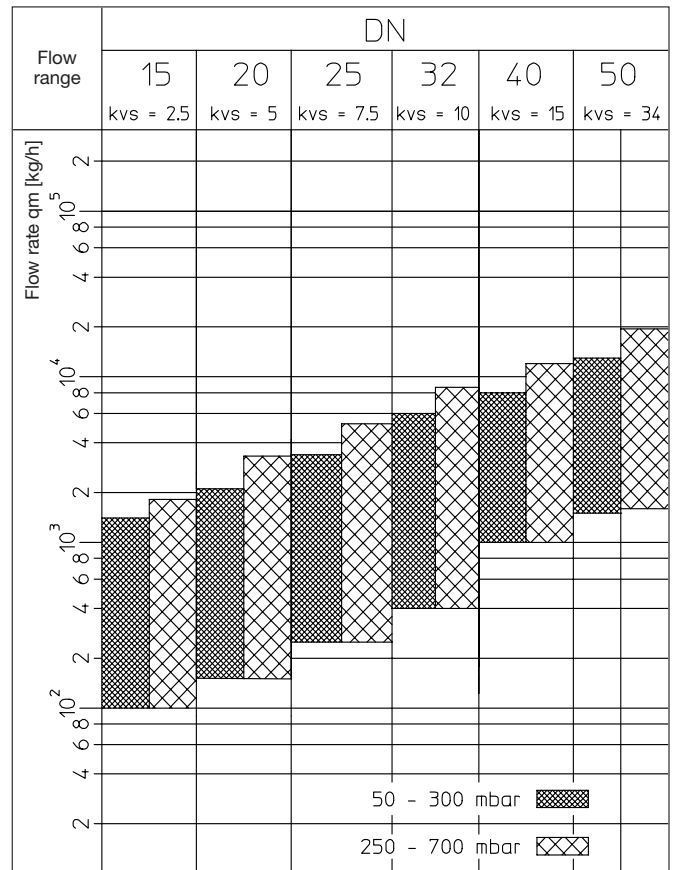

Flow ranges of the differential pressure regulator “Hydromat DTR” for adjustable differential pressures in the circuits 50–300 mbar or 250–700 mbar

The below examples only show the valves which are really required for differential pressure regulation.

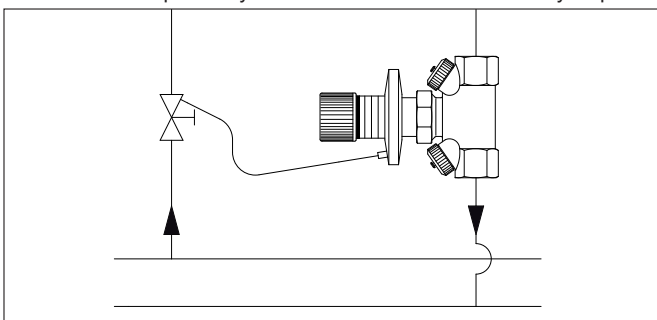

Example: Differential pressure regulation in installations with presettable thermostatic radiator valves (circuits with low to medium flow rate).

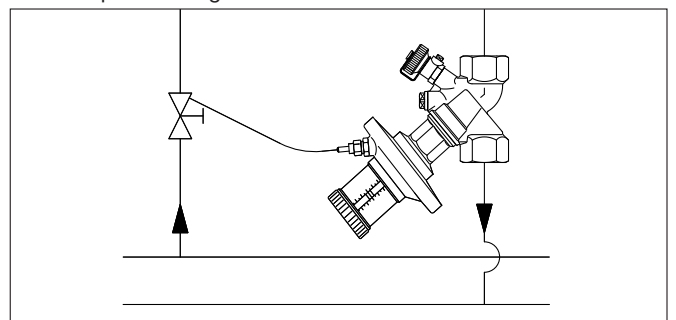

Example: Differential pressure regulation in installations with presettable thermostatic radiator valves (circuits with medium to high flow rate).



### Differential pressure regulation

### Differential pressure regulation with flow limitation



“Hydromat DFC” (200–1000 mbar)  
“Hydromat DFC” (400–1800 mbar)



“Hycocon DTZ” (50–300 mbar)/“Hycocon VTZ”  
“Hycocon DTZ” (250–600 mbar)/“Hycocon VTZ”

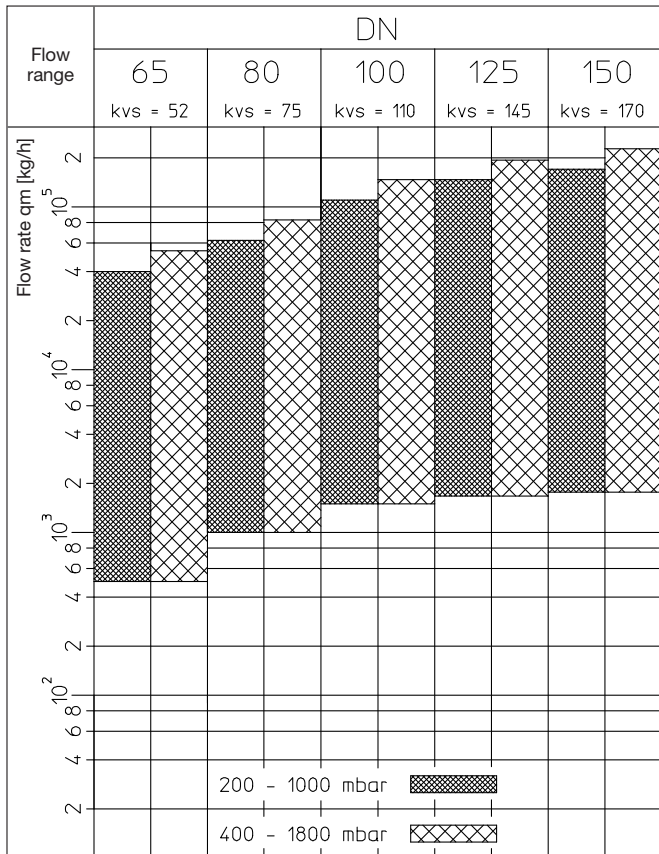

Flow ranges of the differential pressure regulator “Hydromat DFC” for adjustable differential pressures in the circuits 200–1000 mbar or 400–1800 mbar

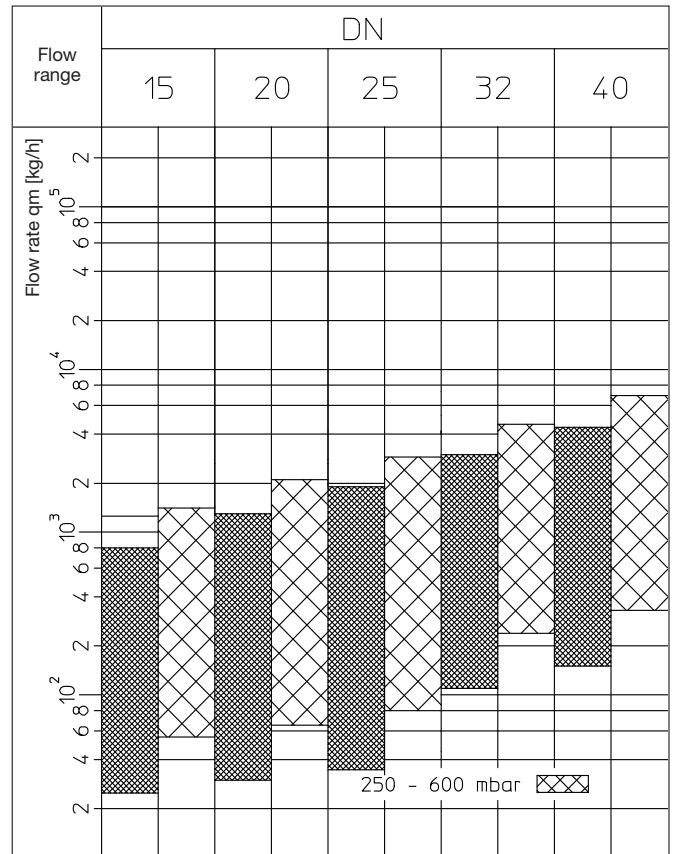

Flow ranges of the differential pressure regulator “Hycocon DTZ” for adjustable differential pressures in the circuits 50–300 mbar or 250–600 mbar and additional flow limitation at the double regulating and commissioning valve “Hycocon VTZ”

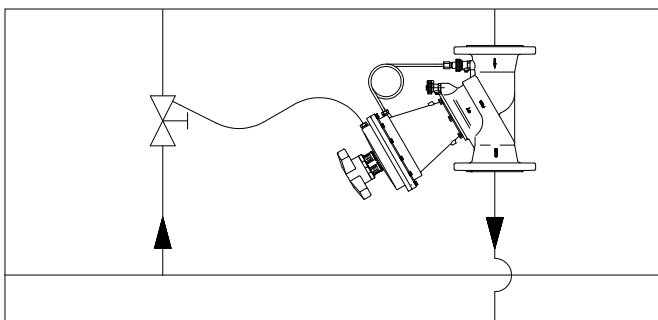

Example: Differential pressure regulation in installations with flanged connections.

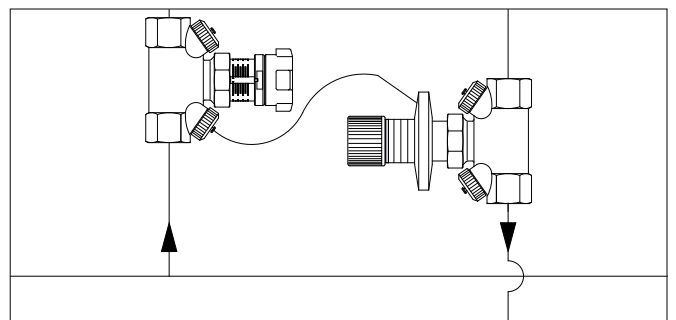

Example: Differential pressure regulation with flow limitation in installations with non presettable thermostatic radiator valves.

### Differential pressure regulation with flow limitation

### Flow regulation



“Hydromat DTR”/“Hydrocontrol VTR”  
“Hydromat DTR”/“Hydrocontrol VFC”



“Hydromat QTR”

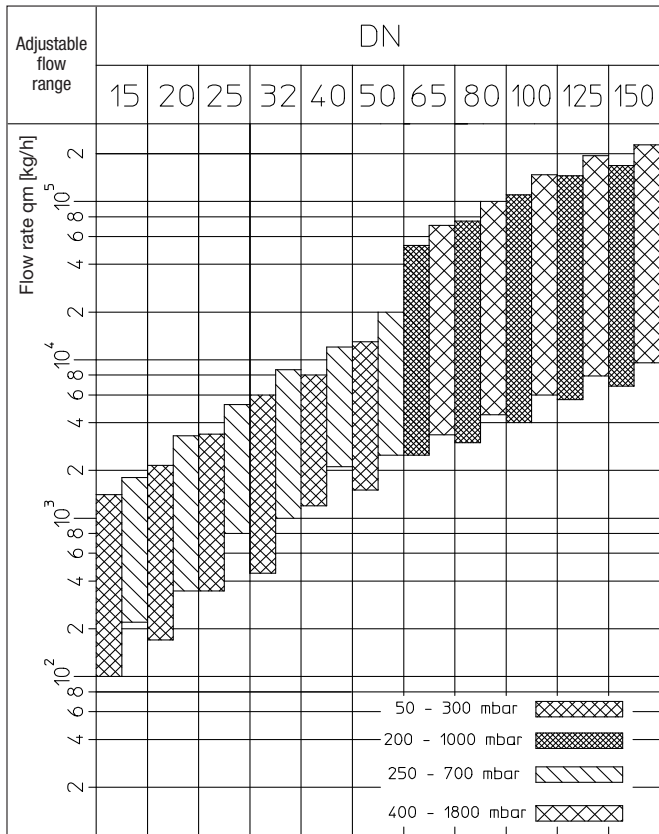

Flow ranges of the differential pressure regulator “Hydromat DTR” for adjustable differential pressures in the circuits 50–300 mbar or 250–700 mbar. For the “Hydromat DFC” differential pressures of 200–1000 mbar or 400–1800 mbar are possible. The additional flow limitation is carried out at the double regulating and commissioning valve “Hydrocontrol VTR/VFR”.

The below examples only show the valves which are really required for regulation.

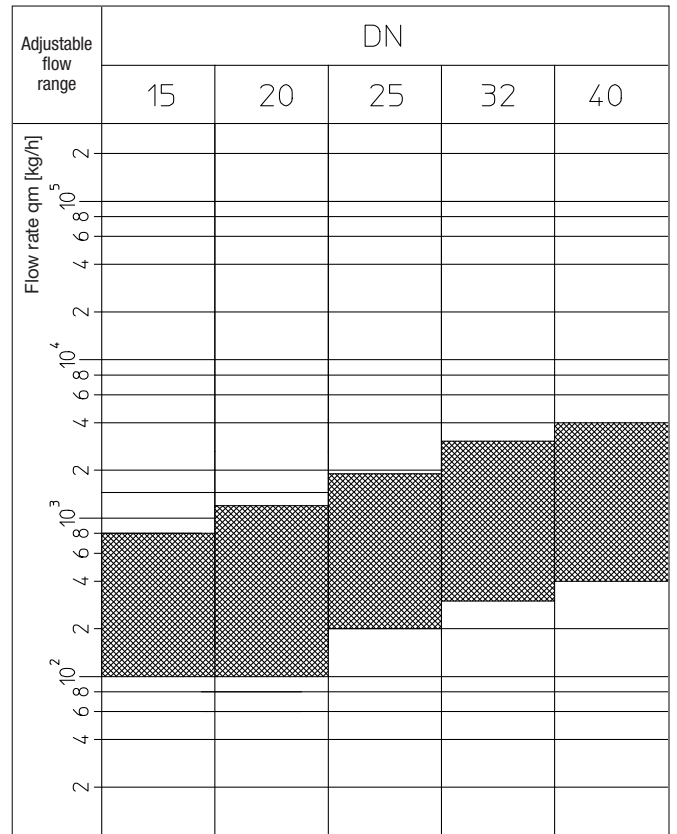

Adjustable flow values at “Hydromat QTR”.

Flow regulation for an application range between 40 kg/h and 4000 kg/h

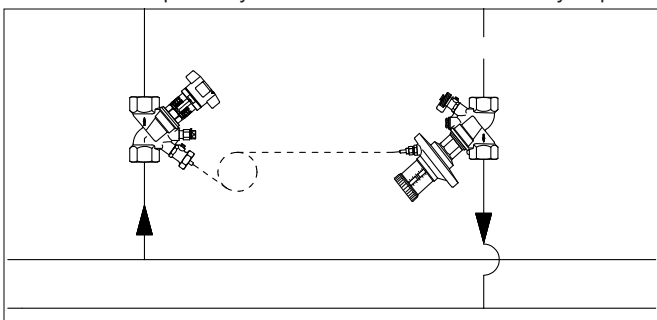

Example: Differential pressure regulation with flow limitation in installations with non-presettable thermostatic radiator valves.

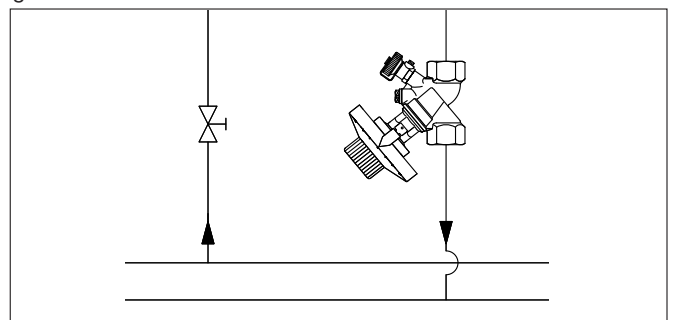

Example: Flow regulation e.g. in cooling systems. Presetting can be set at regulator and is visible from the outside.

### Flow regulation



“Hycococon DTZ”/“Hycococon VTZ”

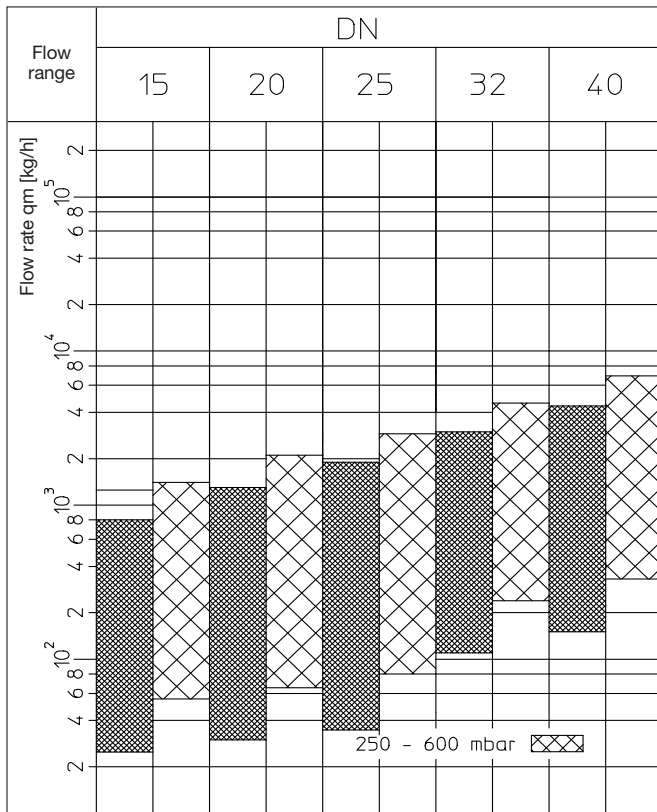

Adjustable flow values for regulation with combination:  
Set differential pressure at “Hycococon DTZ” between 50 and 600 mbar (pressure is taken at “Hycococon VTZ”). With the help of the pressure loss chart (see data sheet “Hycococon VTZ”, design as example 5, page 15) determine the presetting value for “Hycococon VTZ” for the required flow rate and set at the handwheel.

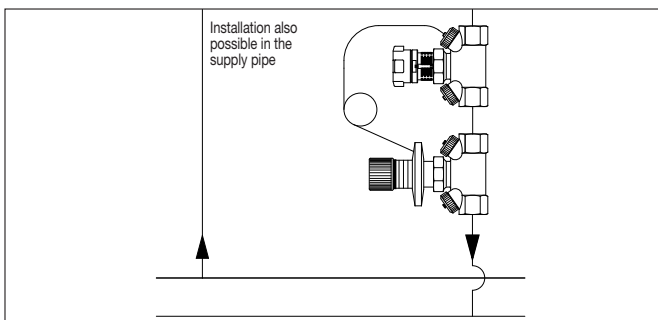

Example: Flow regulation with the help of the combination differential pressure regulator “Hycococon DTZ” and double regulating and commissioning valve “Hycococon VTZ”.

### Flow regulation



“Cocon QTZ/QFC” with actuators

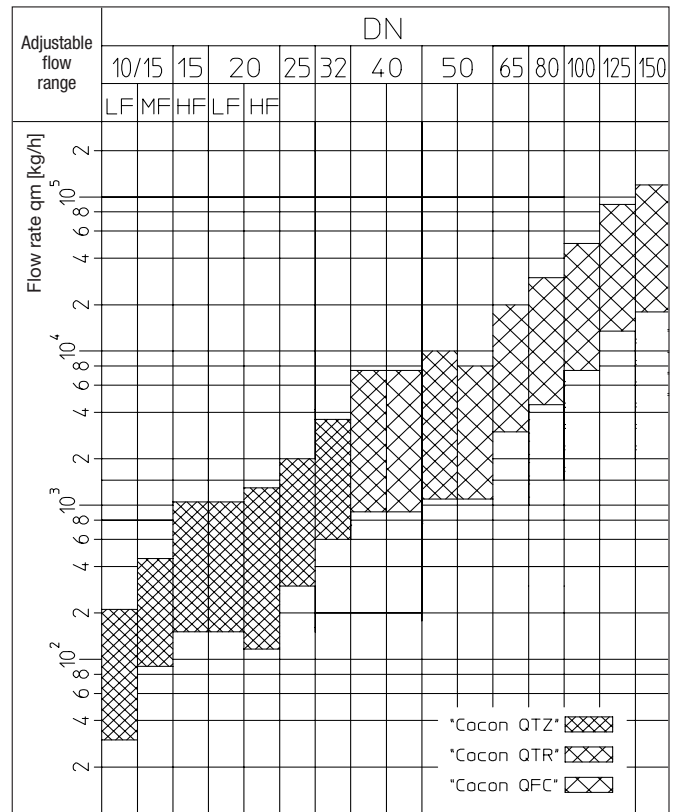

Adjustable flow rates at “Cocon QTZ”/“QTR”/“QFC”:  
Flow regulation for an application range between 30 kg/h–120.000 kg/h. The “Cocon QTR”/“QFC” allow the setting of smaller flow rates up to complete isolation.

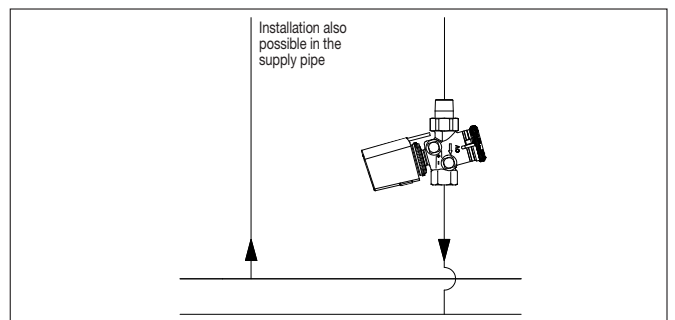

Example: Flow regulation at the pressure independent control valve “Cocon QTZ”.

Flow and temperature balancing by use of regulating valves  
Regulation according to pipework calculation or by using a  $\Delta p$  measuring gauge



Regulating valve "Cocon 2TZ" with integrated metering station

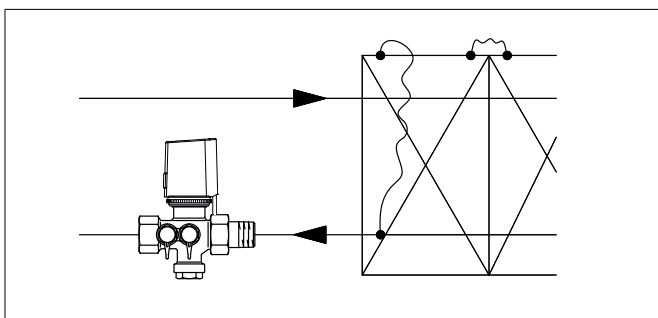
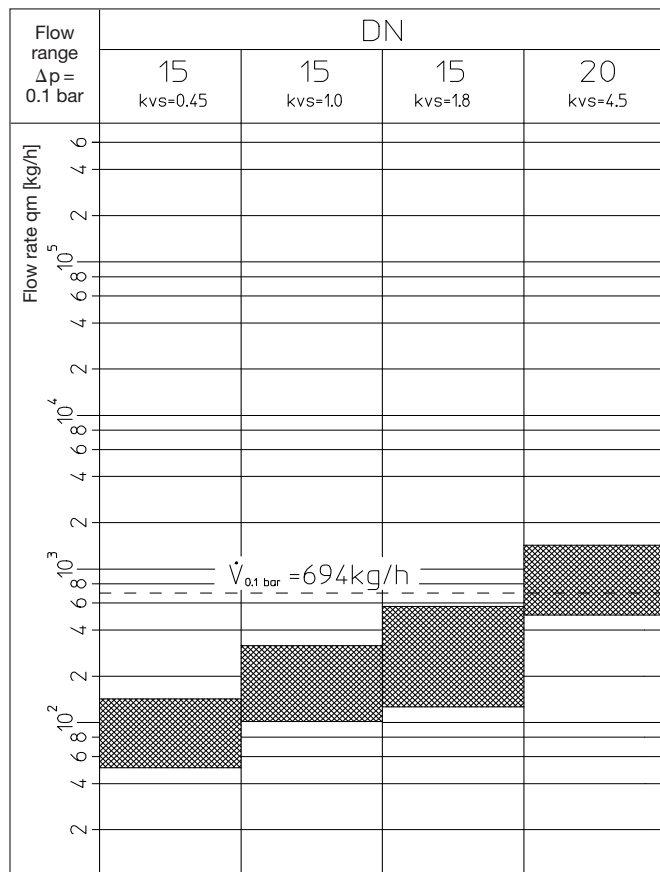

Example: Installation with chilled ceiling system to reduce the room temperature.

Conversion of the flow and differential pressure values from a design calculation on the flow rates with  $\Delta p = 0.1 \text{ bar}$  illustrated here.

Flow balancing by use of metering stations

Regulation according to pipework calculation or by using a  $\Delta p$  measuring gauge



Metering station DN 15 – DN 50

Flow values with  $\Delta p = 1$  bar via the metering station

| DN | kvs                                |      |          |
|----|------------------------------------|------|----------|
|    | Brass resistant to dezincification |      |          |
|    | LF                                 | MF   | Standard |
| 15 | 0.55                               | 1.20 | 2.20     |
| 20 |                                    |      | 4.25     |
| 25 |                                    |      | 8.60     |
| 32 |                                    |      | 15.90    |
| 40 |                                    |      | 23.70    |
| 50 |                                    |      | 48.00    |



Metering station DN 65 – DN 1000

Flow values with  $\Delta p = 1$  bar via the metering station

| DN   | kvs       |                 |
|------|-----------|-----------------|
|      | Cast iron | Stainless steel |
| 65   | 93        | 102             |
| 80   | 126       | 120             |
| 100  | 244       | 234             |
| 125  | 415       | 335             |
| 150  | 540       | 522             |
| 200  | 1010      | 780             |
| 250  | 1450      | 1197            |
| 300  | 2400      | 1810            |
| 350  |           | 2050            |
| 400  |           | 2650            |
| 450  |           | 3400            |
| 500  |           | 4200            |
| 600  |           | 6250            |
| 700  |           | 10690           |
| 800  |           | 14000           |
| 900  |           | 17577           |
| 1000 |           | 22540           |

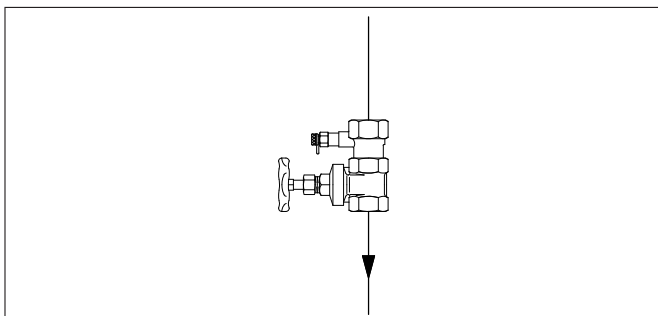

Example: Central heating system with female threaded connections.

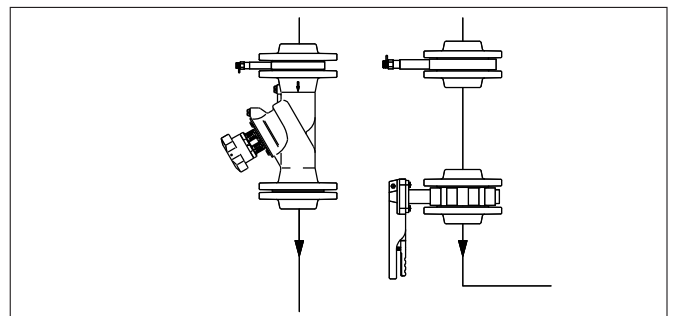

Example: Central heating system with flanged connections.

Example:  $\Delta p_A = 0.15$  bar,  $\dot{V}_A = 850$  kg/h

$$\dot{V}_{0.1 \text{ bar}} = \dot{V}_A \cdot \sqrt{\frac{0.1 \text{ bar}}{0.15 \text{ bar}}} = 694 \text{ kg/h}$$

With the help of the value  $\dot{V}_{0.1 \text{ bar}}$  a preselection, e.g. "Cocon 2TZ", DN 20, can be made (see broken line).

### Double regulating and commissioning valve

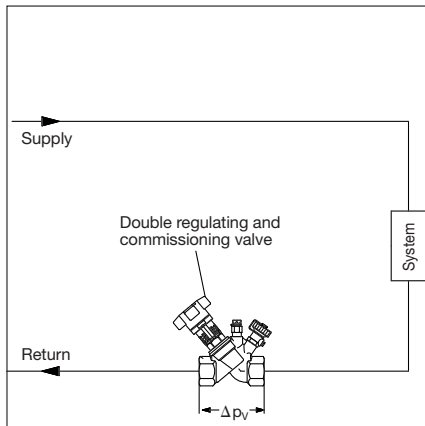

#### Example 1:

Required:  
Presetting "Hydrocontrol VTR"

Given:  
Flow rate circuit  $q_m = 2000 \text{ kg/h}$   
Differential pressure valve  $\Delta p_V = 100 \text{ mbar}$   
Valve size DN 25

Solution:  
Presetting 5.0  
(taken from chart 1060108)

### Differential pressure regulator

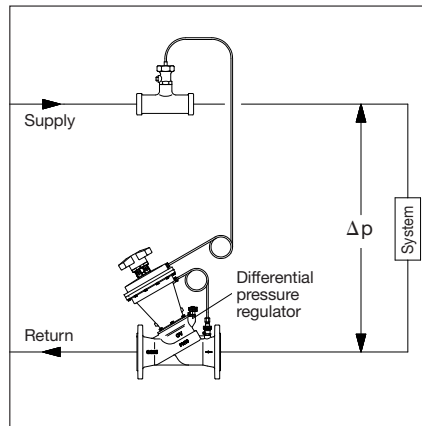

#### Example 2:

Required:  
Size "Hydromat DFC"

Given:  
Flow rate circuit  $q_m = 30000 \text{ kg/h}$   
Differential pressure system  $\Delta p = 800 \text{ mbar}$   
(corresponds to the nominal value setting at the "Hydromat DFC")

Solution:  
Size "Hydromat DFC" DN 65.  
30000 kg/h is smaller than the max permissible flow rate  $q_{m,max}$ .

### Differential pressure regulator and flow limitation with double regulating and commissioning valve

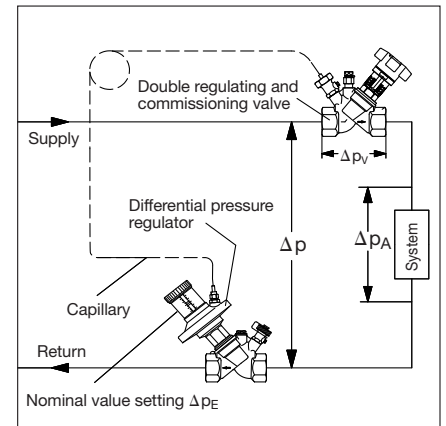

#### Example 3:

Required:  
Presetting double regulating and commissioning valve

Given:  
Differential pressure system  $\Delta p_A = 50 \text{ mbar}$   
Flow rate circuit  $q_m = 2400 \text{ kg/h}$

Differential pressure system (at "Hydromat DTZ")  
 $\Delta p_E = \Delta p = 200 \text{ mbar}$   
Size of pipe DN 32

Solution:  
Presetting 3.0  
(taken from chart 1060110)

Differential pressure of double regulating and commissioning valve  
 $\Delta p_V = \Delta p - \Delta p_A$   
 $= 200 - 50 \text{ mbar}$   
 $\Delta p_V = 150 \text{ mbar}$

### Bronze double regulating and commissioning valve 1060108

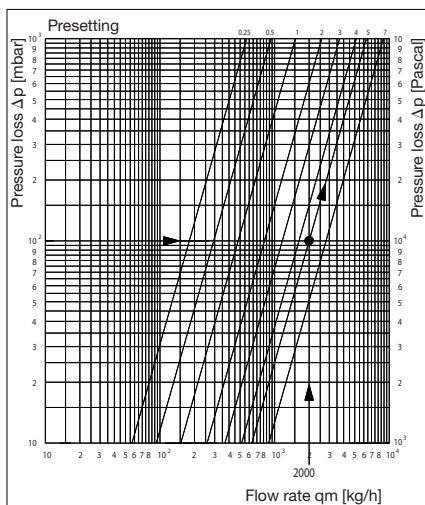

### Differential pressure regulator 1064651

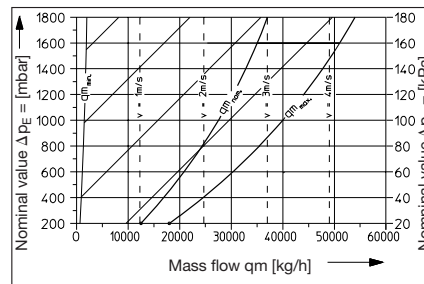

Note:  
Differential pressure system = pressure loss radiator valves and lockshield valves + pressure loss radiator + pressure loss pipework

### Bronze double regulating and commissioning valve 1060110

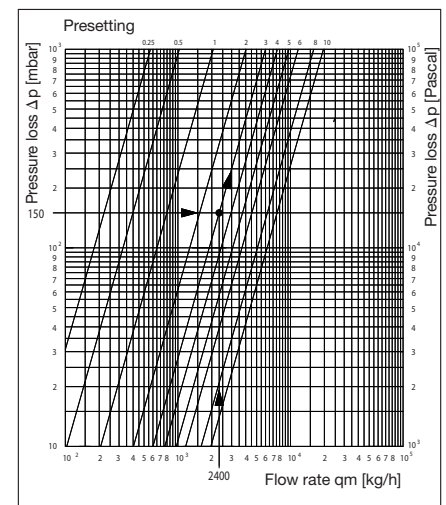

\*The illustrated examples only take those valves into consideration which are required for balancing.

### Flow regulator

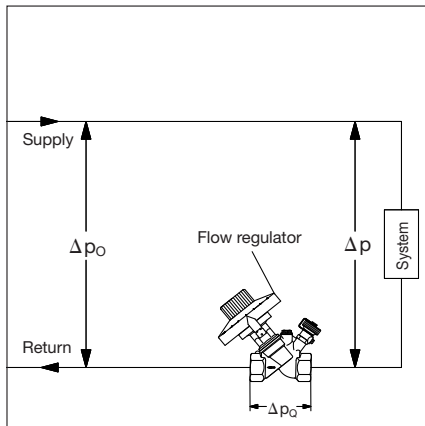

#### Example 4:

Required:  
Size "Hydromat QTR" + differential pressure of regulator  $\Delta p_Q$

Given:  
Flow rate circuit  $q_m = 1000 \text{ kg/h}$   
Existing differential pressure of circuit  $\Delta p_0 = 300 \text{ mbar}$   
Differential pressure of system  $p = 100 \text{ mbar}$

Solution:  
Size "Hydromat QTR" DN 20  
(taken from pressure loss charts DN 15 – DN 40)

According to the charts, the minimum regulator size is chosen for  $q_m = 1000 \text{ kg/h}$ .

The flow regulator has to be set to  $1000 \text{ kg/h}$ .

Differential pressure of regulator  
 $\Delta p_Q = \Delta p_0 - \Delta p$   
 $= 300 - 100 \text{ mbar}$   
 $\Delta p_Q = 200 \text{ mbar}$

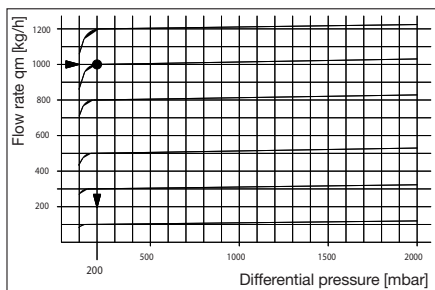

#### Note:

The excessive differential pressure which has to be produced by the regulator, amounts to  $\Delta p_Q = 200 \text{ mbar}$ .

This is the minimum  $\Delta p$  required to ensure accuracy.

### Regulating valve "Cocon QTZ"

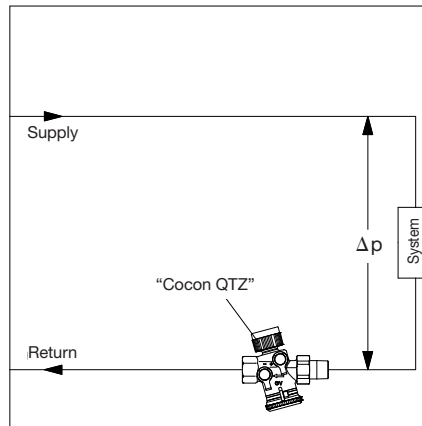

#### Example 5:

Required:  
Size and flow range

Given:  
Flow rate circuit  $q_m = 600 \text{ kg/h}$

Solution:  
"Cocon QTZ", DN 15,  
150 up to 1050 l/h

The regulating valve "Cocon QTZ" has to be set to  $600 \text{ kg/h}$ .

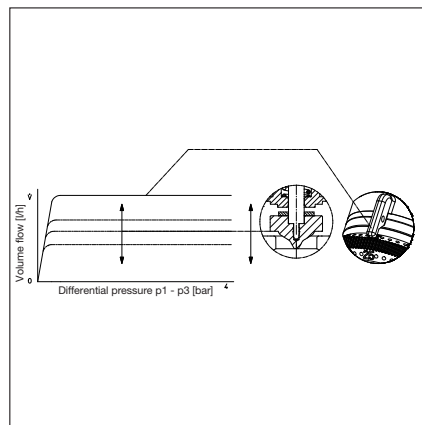

Volume flow characteristic line for different presettings

### Combination of flow and differential pressure regulator for flow and differential pressure regulation

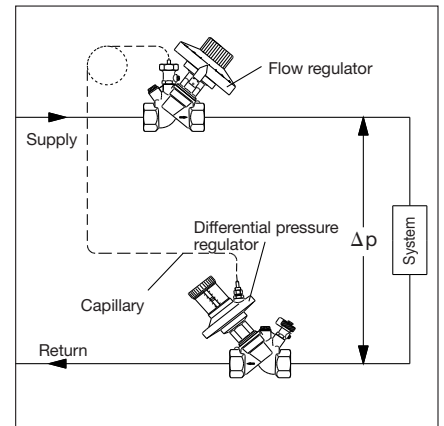

#### Example 6:

The differential pressure and the flow regulator are designed according to examples 2 and 4.

\* The illustrated examples only take those valves into consideration which are required for balancing.



"OV-DMPC"



"OV-DMC 2"

Even a subsequent hydronic balance or a correction at the heating or cooling system leads to an increased economical profit and comfort. For this purpose, Oventrop offers the differential pressure measuring needles for the measuring techniques "classic" and "eco".

The new measuring system "OV-DMPC" is especially designed for an easy regulation on site. The measuring system is equipped with an USB interface for the connection to standard notebooks. Together with the included Windows software, it enables an easy regulation of heating and cooling systems. The "OV-DMPC" is used for differential pressure measurement at regulating valves and the resulting determination of the flow rate. Calculation of the presetting for double regulating and commissioning valves is possible after having entered the valve data and the required nominal flow rate. The characteristic lines of all Oventrop regulating valves are stored in the software. All accessories (e. g. operating keys, measuring adapters etc.) required for flow measurement are included in the service case.

The measuring system "OV-DMC 2" is especially designed for the flow measurement of Oventrop regulating valves. It features a water- and dustproof keyboard and is equipped with an offline rechargeable set of batteries. All accessories (e. g. operating keys, measuring adapters etc.) required for flow measurement are included in the service case. The characteristic lines of all Oventrop regulating valves are stored in the flowmeter. The flow rate is indicated after having entered the valve size and the presetting. To ease handling, zero balance is carried out automatically. If the presetting value of the double regulating and commissioning valve has not been calculated, this can be done by the "OV-DMC 2". After having entered the valve size and the required flow rate, the "OV-DMC 2" calculates the differential pressure, compares the nominal and actual values and the required presetting will be displayed.

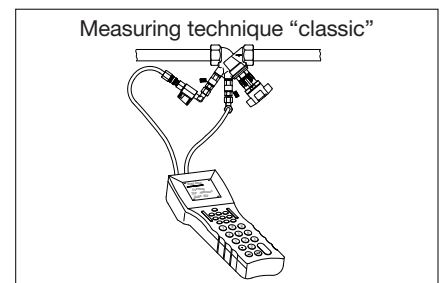

Regulation at double regulating and commissioning valve "Hydrocontrol VTR"

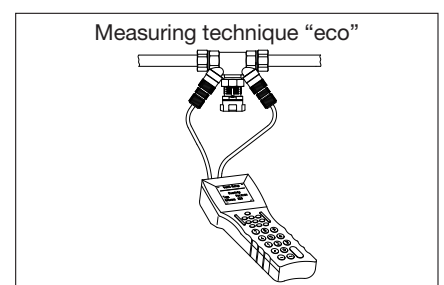

Regulation at double regulating and commissioning valve "Hycoccon VTZ"



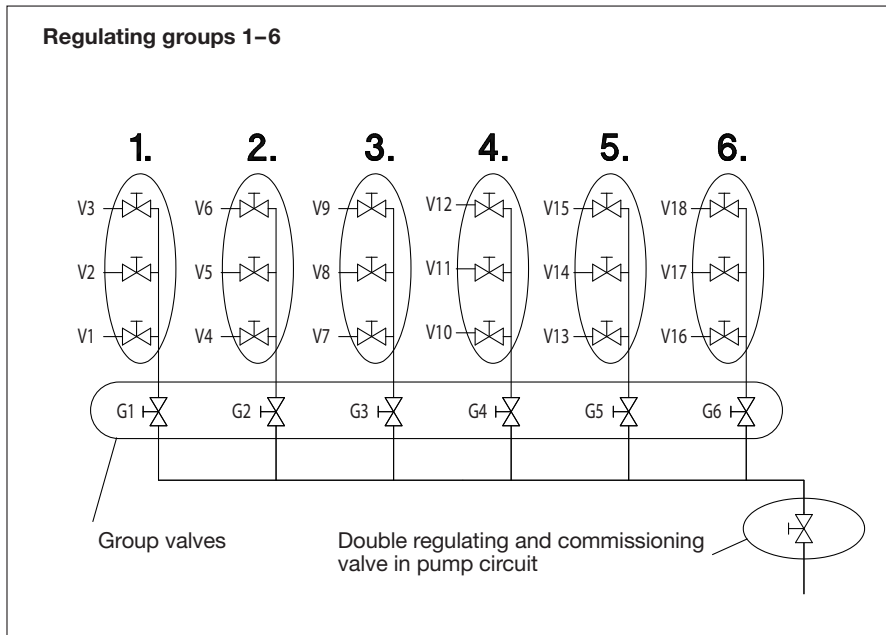

Example: OV-Balance method



"OV-Connect"

### OV-Balance method:

The main advantage of this method is that the values of presetting for the double regulating and commissioning valves may be calculated on site with the help of the Oventrop flow-meter "OV-DMC 2" and that the complete system may be regulated by only one person. The time required for the hydronic balance is reduced considerably provided that the installation is structured clearly.

Before carrying out the regulation, all isolating valves within the circuit of appliance have to be opened. Moreover, the installation has to correspond to the design rate, e.g. thermostatic valves preset and thermostats removed.

The sequence of regulation is detailed in the operating instructions of the "OV-DMC 2" (11 steps).

### Differential pressure transmitter "OV-Connect"

The Oventrop differential pressure transmitter "OV-Connect" is designed to obtain a permanent differential pressure measurement across Oventrop valves with measuring technique "classic" in heating, cooling and potable water systems which are operated with water or water glycol mixtures. The received signals can be processed by an electronic control and monitoring unit.

The differential pressure of the valve is measured via the measuring needles and the 6 mm copper pipes at the pressure test points.

Under working conditions, the appliance passes on an output signal proportional to the measured differential pressure (0 – 10 V).

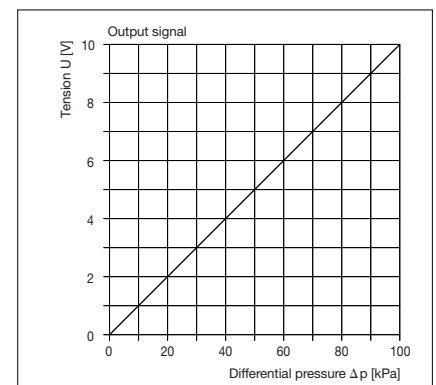

### Application example:

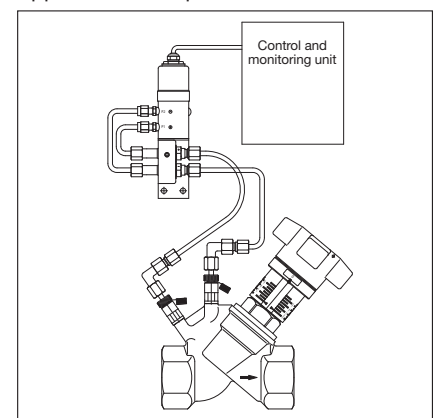

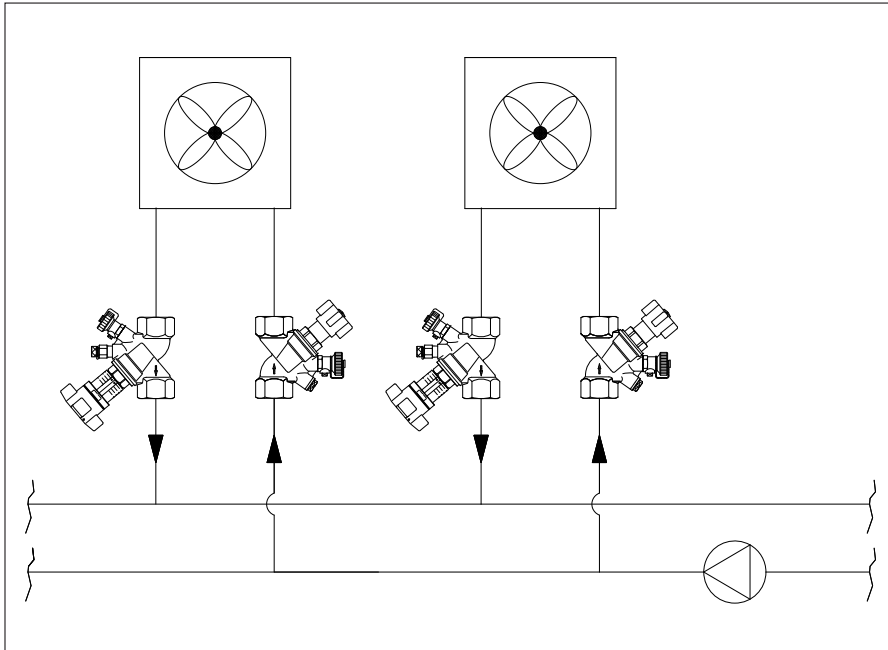

Example:  
Scheme of an air heating installation in which the flow rate is almost constant.  
Preset double regulating and commissioning valves provide a static hydronic balancing.

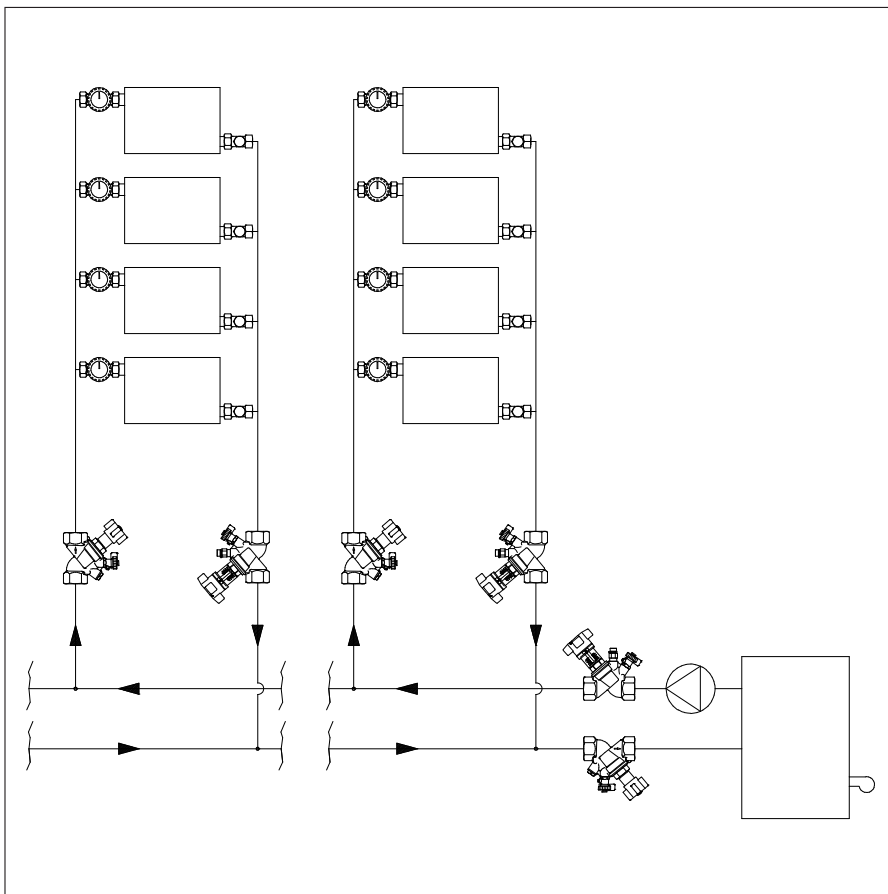

Example:  
Scheme of a two pipe heating system which has to be regulated to a pre-calculated design point by use of double regulating and commissioning valves.

Regulation:  
Via a directly presettable double regulating and commissioning valve.

In principle, correctly sized chilled or heating surfaces, pipes, double regulating and commissioning valves and pumps guarantee an optimum hydronic balance of heating and cooling systems. To minimise deviations of the differential pressure from the design state, the use of regulating valves and regulated pumps may be recommendable.

During planning new heating or cooling systems, heat demand and pipework calculations are used taking the demands of the new decree for energy saving into consideration, including the control and performance ranges of the valves for hydronic balance as well as the losses caused by the resistance of pipes.

To calculate the hydronic of the pipework:

1. the heat demand or the cooling load are determined first,
2. the heating and chilled surfaces as well as their flow rates are calculated with the given temperature differences being taken into consideration,
3. the sizing of the pipework for the flow rates which are to be circulated is carried out. Here, the differential pressure between the circuits, e.g. in heating systems, should be between 100 and 200 mbar,
4. the double regulating and commissioning valves, differential pressure and flow regulators are selected and their values of presetting are determined,
5. the value of presetting (if assigned) is also determined for each appliance,
6. the pump head of the pump is determined.

During the installation phase which is now following, the system is already balanced if the valves for hydronic balance are installed with their values of presetting calculated before. An additional balance is not required.

Examples of application of the procedures described above are illustrated opposite.

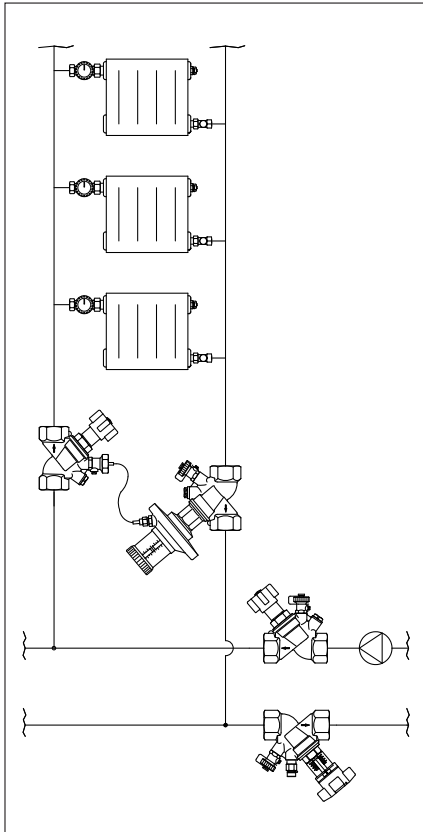

**System illustration:**  
Scheme of a two pipe heating system in which the flow rate is distributed depending on the demand but in which the differential pressure shall not exceed maximum values (limitation of differential pressure).

The values of presetting for presettable thermostatic valves resulting from the pipework calculation represent the optimum flow rate distribution in the design state. A sufficient supply is guaranteed.

The additional application of a differential pressure regulator is useful if the demand is varying, e.g. if a major part of the appliances is closed and the differential pressure of an appliance increases considerably (e.g. more than 200 mbar).

The value of presetting for the differential pressure regulator may also be calculated during the planning stage.

The differential pressure regulators guarantee a permanent control of the differential pressure to the value of presetting within the circuits.

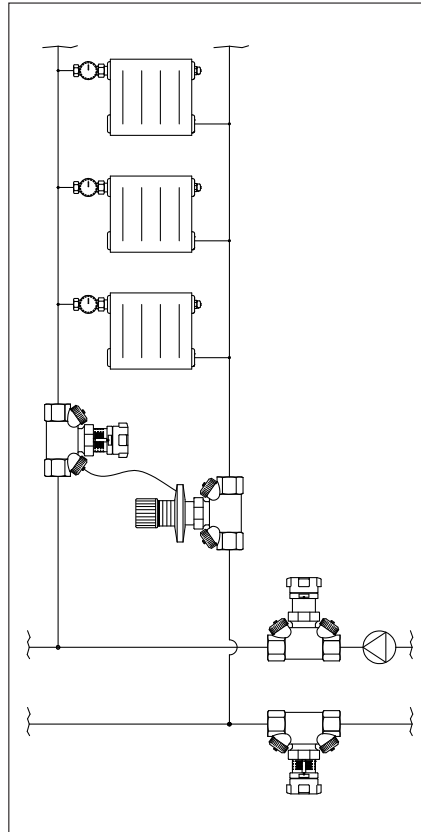

**System illustration:**  
Scheme of a two pipe heating systems with non-presettable thermostatic valves or radiator lockshield valves in which the flow rate is distributed up to a higher constant value depending on the heat demand but in which the differential pressure within a circuit shall not exceed a given maximum value.

This combination of volume and differential pressure limitation is rendered possible by the installation of a double regulating and commissioning valve in the supply pipe and a differential pressure regulator in the return pipe.

Here, the values of presetting for the double regulating and commissioning valve and the differential pressure regulator for the optimum design point also result from the planning stage and the hydronic balance is established automatically.

The differential pressure regulator in combination with the double regulating and commissioning valve then takes over the limitation with the flow rate rising (thermostatic valves open) and the differential pressure rising (thermostatic valves close).

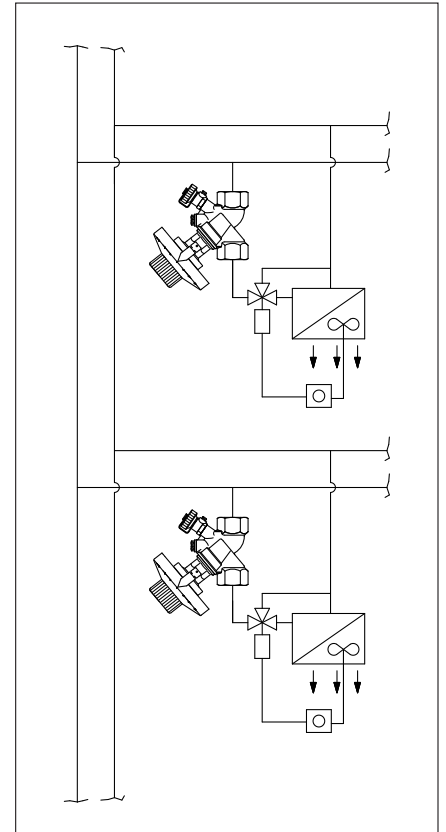

**System illustration:**  
Scheme of a cooling system in which the flow rate towards the chillers shall remain constant and independent of the demands within the other sections of the system (limitation of the flow rates).

For such installations, the distribution of the flow rate for the circuits results from calculation programs. The values may be set directly at the flow regulators.

In case of varying demand, the automatic flow regulator guarantees an automatic adaptation of the flow rate to the set value within the circuits.

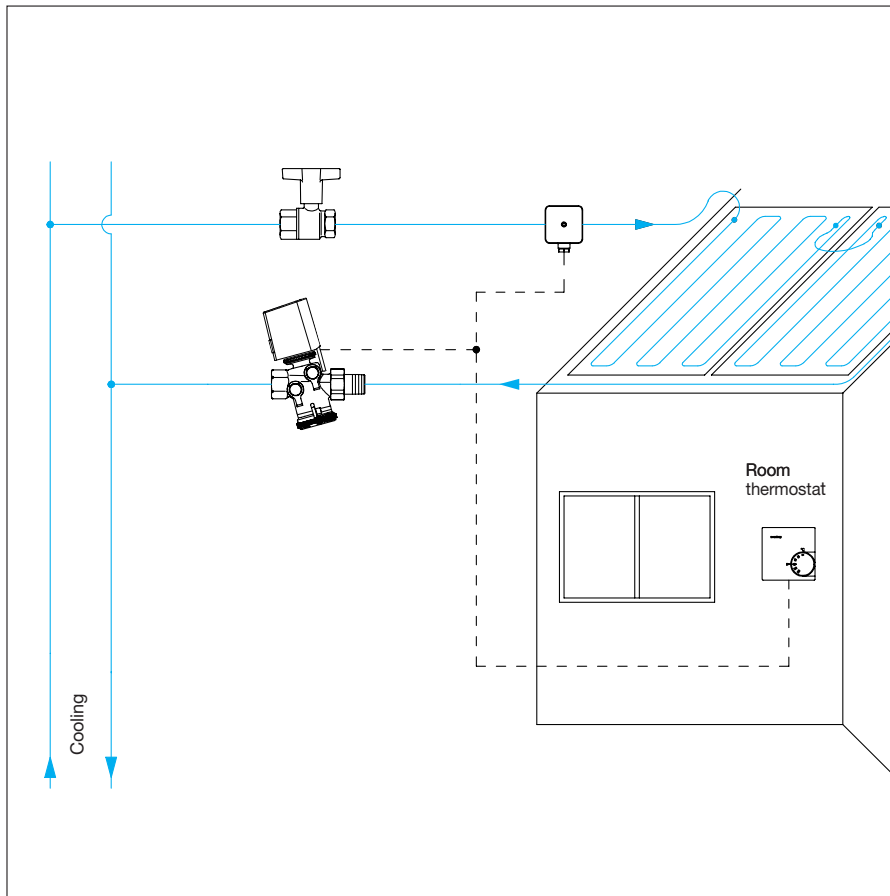

### 1 Two pipe cooling system

The simplest method to reduce the room temperature by using a chilled ceiling system is illustrated by the two pipe system.

For this purpose, Oventrop offers the following products:

- the presettable pressure independent control valve "Cocon QTZ" is installed in the return pipe of the chilled ceiling for the regulation of the chilled water flow
- an electric actuator receiving control commands from a room thermostat is mounted on the valve
- a ball valve is installed in the supply pipe of the chilled ceiling to shut off the chilled water flow. A dew point control which shuts off the flow of chilled water in case of condensation is installed in the supply pipe

### 2 Two pipe cooling/heating system

If a two pipe system is also used for heating, the following products could be used:

- valve "Cocon 2TZ" with electric actuator
- dew point control
- double regulating and commissioning valve
- differential pressure regulator

Here, a central changeover of the supply and return pipe from cooling to heating operation takes place and vice versa. During cooling operation, the valve "Cocon 2TZ" is opened via a room thermostat in case of rising room temperature.

During heating operation, the "Cocon 2TZ" valve is closed via a room thermostat with the room temperature rising.

1

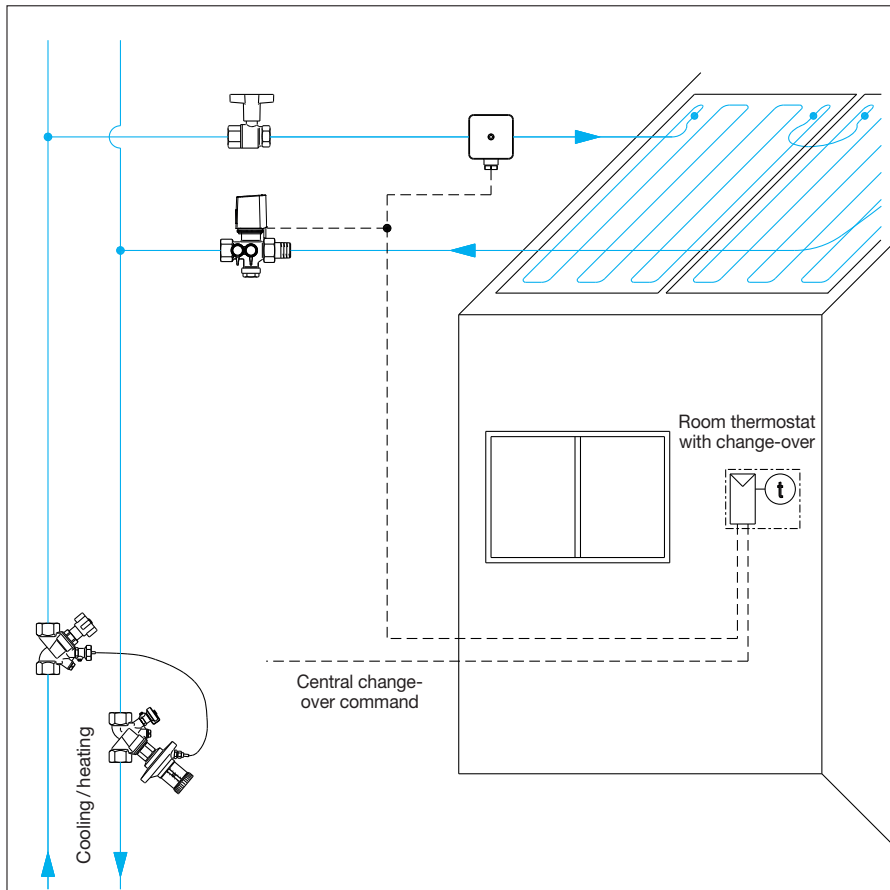

2

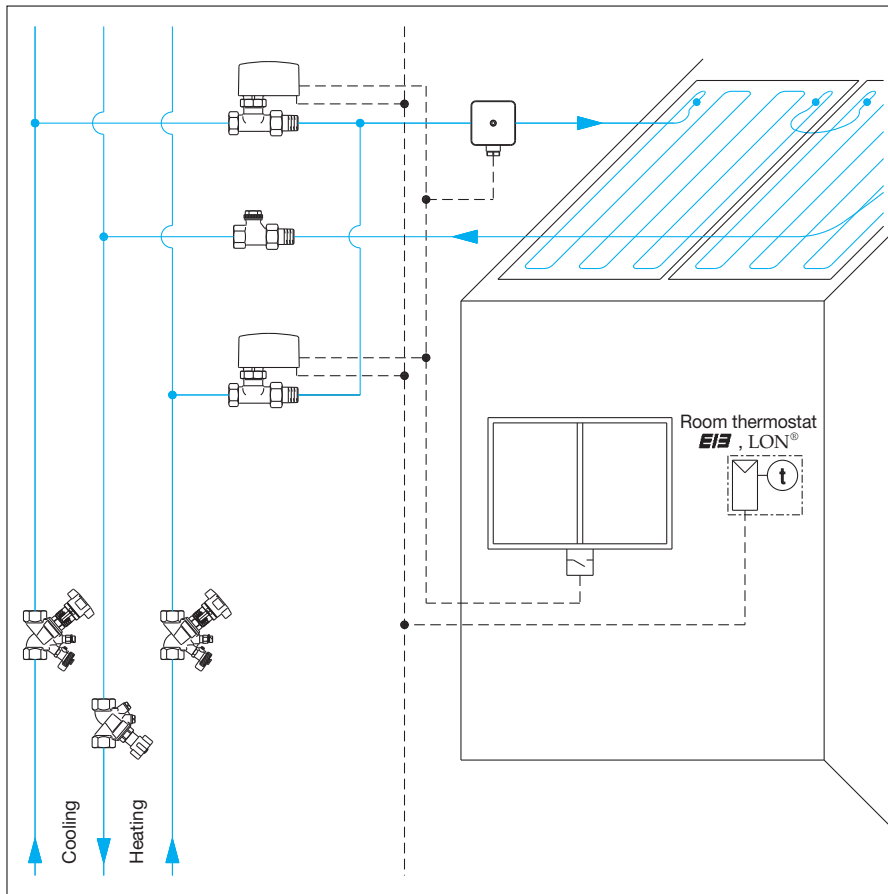

### 1 Three pipe cooling/heating system

A three pipe system is used if the fluid for cooling operation and the fluid for heating operation are transported in separate supply pipes and if they are fed back to the cooler or the heat source in a common pipe. During cooling operation, the actuator "Uni EIB" which is controlled by the EIB system, ensures, with the valve of the "Series P", the supply to the chilled or radiant ceiling element. Moreover, the binary entry of the actuator "Uni EIB" allows the connection of a dew point control device and/or a window contact. The supply of the heating fluid is controlled the same way. The mass flow is regulated by use of the common radiator lockshield valve "Combi 3" also allowing filling and draining.

### 2 Four pipe heating/cooling system

A four pipe system is used if the common connections to the chilled or radiant ceiling are served by separate heating and cooling supply and return pipes. The chilled and heating water flows are adjusted by the pressure independent control valves "Cocon QTZ", complete with electrothermal actuators, which are mounted on the return pipe. An activated isolation valve, comprising of a "Series AZ" high kv valve and electrothermal actuator is mounted on each supply pipe, will be closed in combination with the appropriate return valve when the chilled radiant panel switches between heating and cooling modes. To avoid condensation, the dew point control closes the chilled water return valve via the actuator.

1

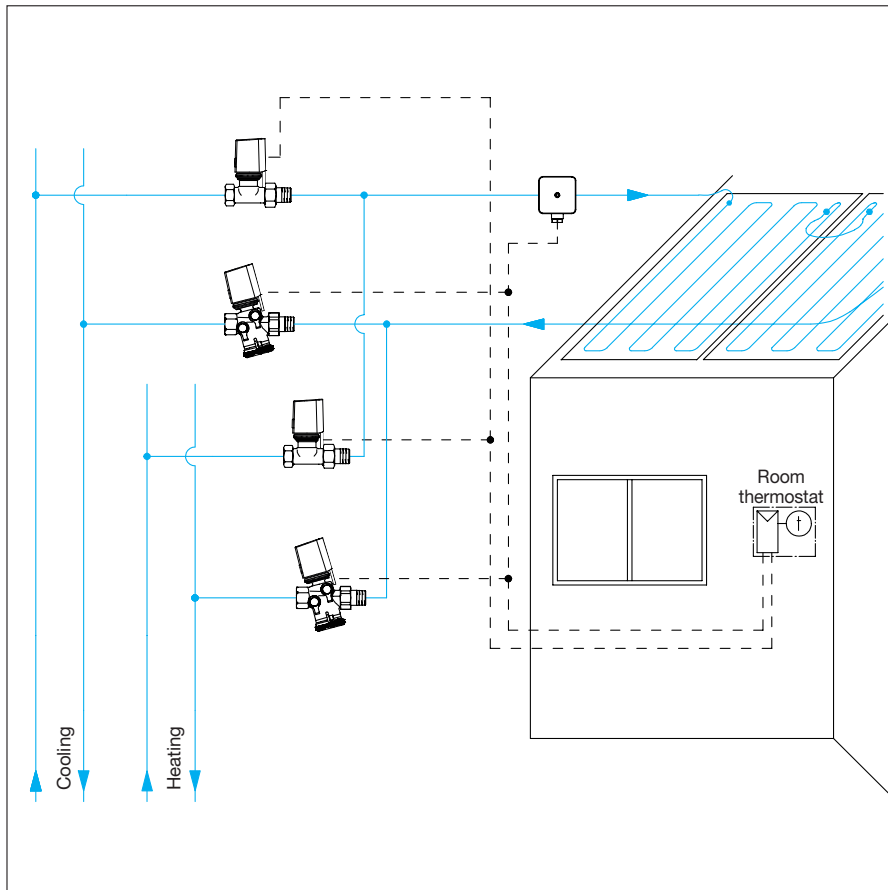

2



1



2

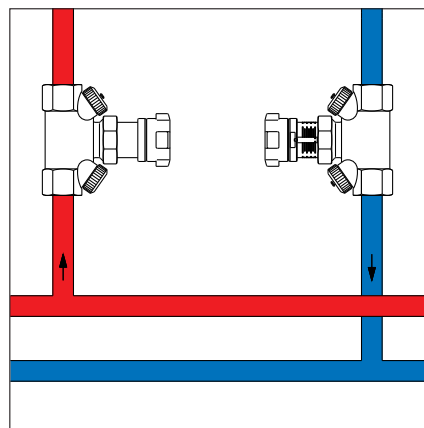

3



4

The Oventrop series "Hycococon" made of DZR brass comprises small, compact valves for use in heating, cooling and air conditioning systems PN 16 between  $-10^{\circ}\text{C}$  and  $+120^{\circ}\text{C}$ .

The series "Hycococon" consists of the following components:

- "Hycococon VTZ": Double regulating and commissioning valve
- "Hycococon ATZ": Isolating and orifice valve
- "Hycococon ETZ": Regulating valve with AV6 insert for thermostats or actuators
- "Hycococon HTZ": Regulating valve with special insert for high flow rates and for thermostats and actuators
- "Hycococon DTZ": Differential pressure regulator

Connection thread M 30 x 1.5

The sizes DN 15, DN 20, DN 25, DN 32 and DN 40 are available and the valves may be supplied with female or male threaded connection. Installation is possible in the supply and the return pipe.

The valves "Hycococon VTZ" and "Hycococon ATZ" are supplied with insulation shell (suitable up to  $80^{\circ}\text{C}$ ). The new valve insert of the "Hycococon" valves allows the replacement of the handwheels or the bonnets for isolation, regulation and differential pressure regulation without draining the system (DN 15, DN 20, DN 25 with the help of the "Demo-Bloc"). Combined with a thermostat, temperature controller or electrothermal or electromotive actuator, the "Hycococon ETZ/HTZ" valves may be used as a dynamic regulating valve. When fitted with an electromotive actuator EIB or LON<sup>®</sup>, it may even be used as an intelligent regulating valve.

With these universal connection possibilities, Oventrop offers a practical and effective solution for any automatic and manual hydronic balancing in the Building Services Industry.

- 1** "Hycococon HTZ" with bonnets
  - double regulating and commissioning valve
  - differential pressure regulator
  - isolating and orifice valve
- 2** "Hycococon HTZ" with thermostat, electrothermal or electromotive actuator

**3** System illustration  
Isolating and orifice valve "Hycococon ATZ" and double regulating and commissioning valve "Hycococon VTZ" in a heating riser

**4** "Hycococon VPZ" and "Hycococon APZ" both ports with press connection. For the direct connection of copper pipes according to EN 1057 or stainless steel pipes.



1

Oventrop double regulating and commissioning valves "Hycococon VTZ" are installed in hot water central heating and cooling systems and serve to achieve a hydronic balance between the various circuits of the system.

Precise balancing can be achieved due to an infinitely adjustable presetting with memory position which is lockable and lead sealable. Sizes DN 15 to DN 25 with six and sizes DN 32 and DN 40 even with eight major graduation values divided into steps of  $\frac{1}{10}$ th (i. e. 60 or 80 presetting values) guarantee a high resolution with small flow tolerances.

Installation is possible in either the supply or the return pipe.

Advantages:

- supplied with insulation shell (suitable up to 80 °C)
- the location of all functioning components on one level allows a simple assembly and easy operation
- only one valve for 5 functions:
  - presetting
  - measuring
  - isolating
  - filling
  - draining
- supplied with mounted pressure test point and drain valve (measuring technique "eco")
- easy filling and draining by fitting a separate tool (accessory) to one of the pressure test points
- infinitely adjustable presetting, exact measurement of pressure loss and flow with the help of the pressure test points
- thread according to EN 10226 (BS 21) suitable for Oventrop compression fittings (one edge olive) for copper pipes with a max. diameter of 22 mm as well as Oventrop composition pipe "Copipe" 14 and 16 mm

Models available: both ports female or male thread.

Dimensions and flow capacities:

- DN 15  $k_{VS} = 1.7$
- DN 20  $k_{VS} = 2.7$
- DN 25  $k_{VS} = 3.6$
- DN 32  $k_{VS} = 6.8$
- DN 40  $k_{VS} = 10.0$

**1** Double regulating and commissioning valve "Hycococon VTZ"

Model: both ports female thread according to EN 10226 (BS 21)

Awards:

**ISH** ISH Frankfurt  
"Design Plus"

design preis switzerland Design Award Switzerland

**if** International Forum  
Design Hanover  
iF design award

 Nominated for the  
Design Award of the  
Federal Republic of Germany

**2** Double regulating and commissioning valve "Hycococon VTZ" combined with flow-meter "OV-DMC 2"

**3** Presetting  
Basic and fine setting scale

**4** Pressure test points for use with flow-meter "OV-DMC 2"



2



3



4

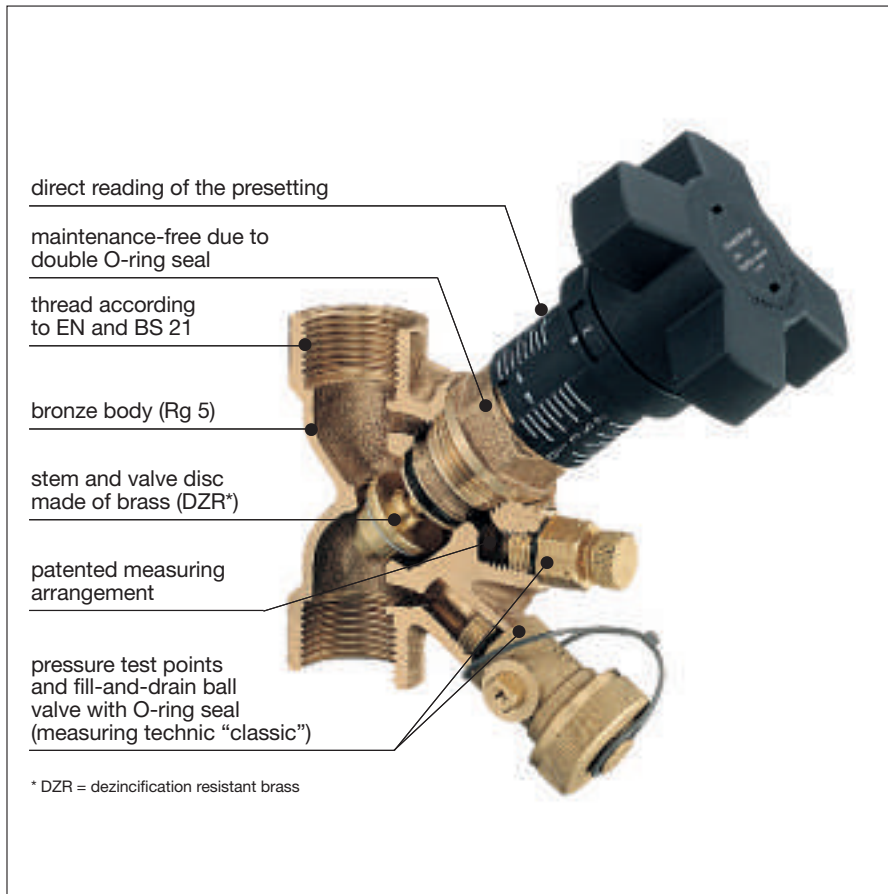

1

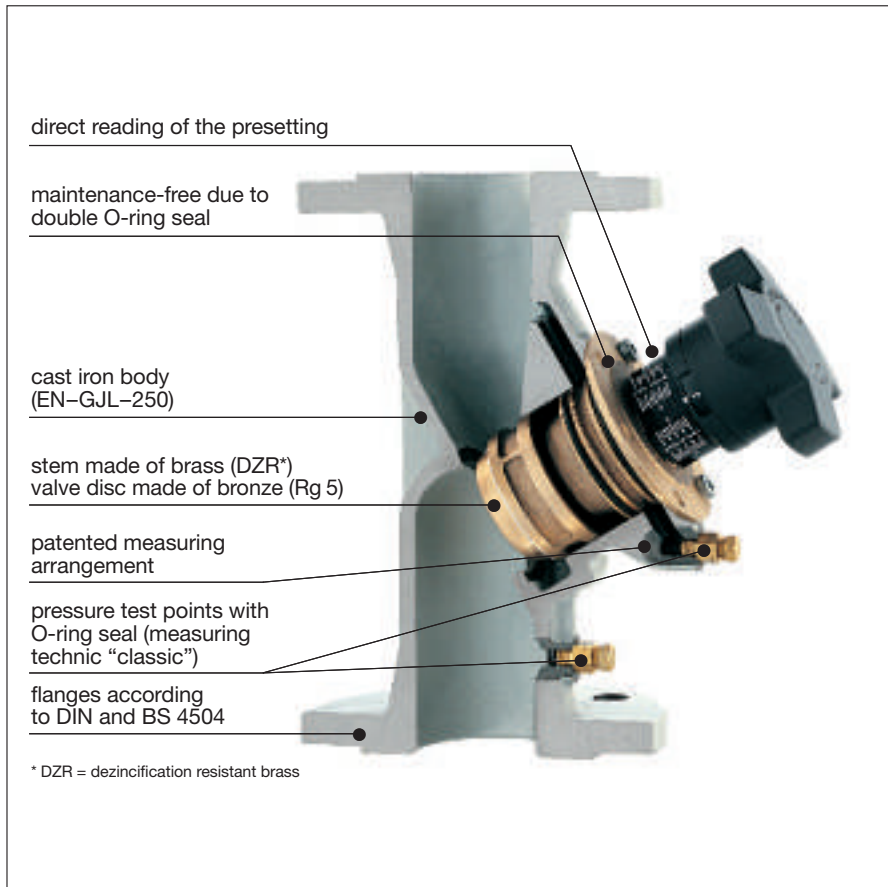

2

With their balancing systems, Oventrop offers the installer all the valves and valve combinations necessary to achieve the hydronic balance of heating and cooling systems. The products can be delivered separately or as a system. Thus the appropriate valves and valve combinations are available for any possible demand.

The bronze double regulating and commissioning valves "Hydrocontrol VTR"/"Hydrocontrol VFC" are installed in hot water central heating systems ("Hydrocontrol VTR": PN 25/150 °C, with press connection: max. 120 °C, "Hydrocontrol VFC": PN 16/150 °C) and cooling systems in order to provide a hydronic balance between the various circuits of the system. The bronze double regulating and commissioning valves "Hydrocontrol VFR" are also suitable for cold salt water (38 °C max.) and domestic water. The calculated flow rate or pressure loss can be preset for each individual circuit, thus making the hydronic balance easy to achieve.

They can be installed in either the supply or the return pipe.

Advantages:

- the location of functioning components on one level allows a simple assembly and easy operation
- only one valve for 5 functions:
  - presetting
  - measuring
  - isolating
  - filling
  - draining
- low pressure loss (oblique pattern)
- infinitely adjustable presetting, exact measurement of pressure loss and flow by using the pressure test points (measuring technique "classic")
- thread of "Hydrocontrol VTR" according to EN 10226 (BS 21), suitable for Oventrop compression fittings (one edge olive) for copper pipes with a max. diameter of 22 mm
- flanges of "Hydrocontrol VFN", "Hydrocontrol VFR" and "Hydrocontrol FR": round flanges according to DIN EN 1092-2 (BS 4504), lengths according to DIN EN 558-1 (BS 7350), basic series 1
- groove connections for couplings of "Hydrocontrol VGC" suitable for couplings of the systems Victaulic and Grinnell
- fill and drain ball valve with internal stop and pressure test point with O-ring seal between valve body and test point (no additional seals required)
- patented measuring channel led around the stem assembly to the test points ensures the best possible accuracy between the differential pressure measured at the pressure test points and the actual differential pressure of the valve.

**1** Sectioned double regulating and commissioning valve "Hydrocontrol VTR"

Awards:

 International Design Award Baden-Württemberg

 Good Design Award Japan

 International Forum Design Hanover Award iF

**2** Sectioned double regulating and commissioning valve "Hydrocontrol VFC"

Award:

 Pragothem Prague Diploma for the best exhibit



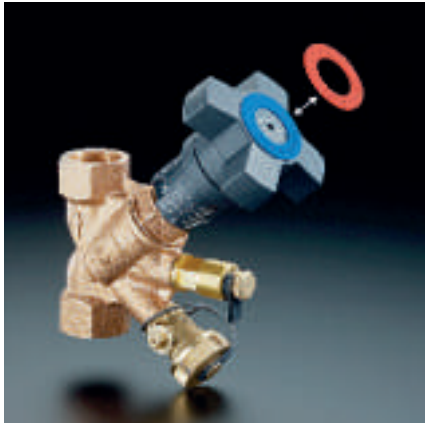

1



2



3



4



5



6



7

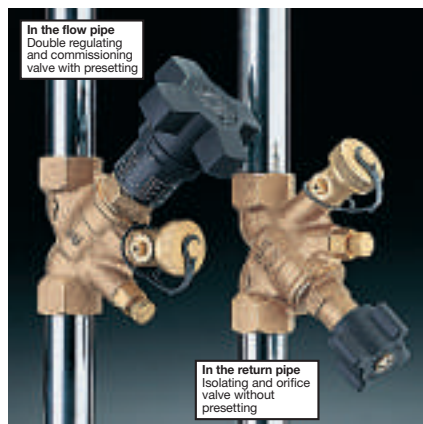

8

**1** Double regulating and commissioning valve “Hydrocontrol VTR” both ports female thread according to EN 10226 and BS 21, sizes DN 10 – DN 65 both ports male thread with collar nuts, sizes DN 10 – DN 50 or both ports press connection, sizes DN 15 – DN 50. Complies with BS 7350 and BS 5154. Body and bonnet made of bronze Rg5, valve disc with PTFE seal, stem and valve disc made of dezincification resistant brass. DVGW, SVGW and WRAS approval for DN 15 – DN 32.

The valves “Hydrocontrol VTR” in the supply respectively return pipe can be clearly marked by use of the replaceable colour rings.

**2** Possible connections for the model “Hydrocontrol VTR” with both ports male thread:

- weldable tailpipes
- solder tailpipes
- male screwed tailpipes
- female screwed tailpipes
- connection piece for all pipes

**3** Double regulating and commissioning valve “Hydrocontrol VPR” both ports with press connection. For the direct connection of copper pipes according to EN 1057 or stainless steel pipes.

**4** Double regulating and commissioning valve “Hydrocontrol VFC” PN 16 both ports flanged, sizes DN 20 – DN 400. Body made of cast iron EN-GJL-250 DIN EN 1561, valve disc with PTFE seal, bronze bonnet (D 200-DN 400 made of nodular cast iron), stem and valve disc made of dezincification resistant brass, sizes DN 65 and above bronze valve disc.

Round flanges according to DIN EN 1092-2 Lengths according to DIN EN 558-1, basic series 1 and BS 7350

Also available with hole circle according to ANSI-Class 150

**5** Double regulating and commissioning valves “Hydrocontrol VFR”-PN 16/ “Hydrocontrol VFN” – PN 25

– Double regulating and commissioning valve “Hydrocontrol VFR” – PN 16 both ports flanged, sized DN 50 – DN 200. Body, bonnet and disc made of bronze, stem made of stainless steel. Dimensions of flanges identical with “Hydrocontrol VFC”.

Round flanges according to DIN EN 1092-2 Lengths according to DIN EN 558-1 basic series 1 and BS 4504

– Double regulating and commissioning valve “Hydrocontrol VFN” – PN 25 both ports flanged, sized DN 65 – DN 300. Body made of nodular cast iron EN-GJS-500.

Round flanges according to DIN EN 1092-2 Lengths according to DIN EN 558-1 basic series 1 and BS 4504

**6** “Hydrocontrol AFC” Sizes DN 65 – DN 150

**7** Double regulating and commissioning valve “Hydrocontrol VGC” both ports groove connection for couplings, DN 65 – DN 300.

Suitable for couplings of the systems Victaulic and Grinell. Body made of cast iron EN-GJL-250 DIN EN 1561, disc with PTFE seal, bonnet (DN 200 – DN 300 made of nodular cast iron) and valve disc made of bronze, stem made of brass resistant to dezincification.

**8** Valves for supply and return pipe The valve for the return pipe has the same functions as the double regulating and commissioning valve “Hydrocontrol VTR” except for the presetting.

In the flow pipe  
Double regulating  
and commissioning  
valve with presetting

In the return pipe  
Isolating and orifice  
valve without  
presetting



1

### 1 Differential pressure regulator “Hycocon DTZ”

The differential pressure regulator is a proportional regulator working without auxiliary energy. It is designed for use in heating and cooling systems to maintain a constant differential pressure within a necessary proportional band. The nominal value is infinitely adjustable between 50 mbar and 300 mbar or 250 mbar and 600 mbar. PN 16, 120 °C

- high flow capacity
- nominal value can be locked
- very good optical display of the nominal value at any time
- installation in the return pipe
- with isolating facility
- supplied with drain valve
- easy filling and draining by screwing separate tool (accessory) onto one of the pressure test points (possibility to connect a flexible hose)
- pressure balanced valve disc
- all functioning components on one level
- thread according to EN 10226 (BS 21) suitable for Oventrop compression fittings (one edge olive) for copper pipes with a max. diameter of 22 mm as well as Oventrop composition pipe “Copipe” 14 and 16 mm
- female and male thread



2

### 2 Differential pressure regulator “Hydromat DTR”

The differential pressure regulator is a proportional regulator working without auxiliary energy. It is installed in heating and cooling systems of existing and new buildings for a decentral or central regulation of the differential pressure.

The regulators maintain a constant differential pressure within a necessary proportional band. The sizes DN 15 to DN 50 are infinitely adjustable between 50 mbar and 300 mbar and size DN 50 additionally between 250 mbar and 700 mbar.

The “Hydromat DFC” sized DN 65 to DN 100 is infinitely adjustable between 200 mbar and 1000 mbar or 400 mbar and 1800 mbar.

Additional technical information:

PN 16, -10 °C up to 120 °C

Connections DN 15 to DN 50:

- both ports female thread according to EN/BS

- both ports male thread with collar nut

Connections DN 65 to DN 150:

- both ports flanged according to DIN EN 1092-2, PN 16 (corresponds to ISO 7005-2, PN 16)

Lengths according to DIN EN 558-1, basic series 1 (corresponds to ISO 5752 series 1)

Advantages:

- high flow capacity
- nominal value can be locked
- very good optical display of nominal value at any time
- installation in the return pipe (DN 15 to DN 50)
- with isolating facility
- with ball valve for filling and draining
- pressure balanced valve disc
- existing double regulating and commissioning valves can be converted to differential pressure regulators (identical bodies)
- all functioning components on one level

This item is protected by patent.

Awards:

 Industrial Forum Design Hanover Award iF

 Pragothem, Prague, Grand Prix



The flow regulators “Hydromat QTR”, “Cocon QTZ” and “Cocon QFC” are proportional regulators working without auxiliary energy. They are designed for use in heating and cooling systems to maintain a constant flow within a necessary proportional band.

Additional technical information:

**1 “Hydromat QTR”:**

PN 16 up to 120 °C

Connections alternatively

- both ports female thread according to EN
  - both ports male thread and collar nuts
- Corrosion resistant due to bronze material  
DN 15 – DN 40

Advantages:

- control range 0.2 – 2 bar
- high flow capacity
- installation in the supply or return pipe
- with isolating facility
- with ball valve for filling and draining
- pressure balanced valve disc
- very good optical display of nominal values at the handwheel
- nominal value lockable and lead sealable
- existing double regulating and commissioning valves can be converted to flow regulators (identical bodies)
- all functioning components on one level
- no need to exchange regulation inserts to modify nominal values

This item is protected by patent.

Awards:



Industrial Forum Design Hannover Award iF



Aquatherm Prague



Interclima Paris  
Trophée du Design



Design Award Switzerland

**2 “Cocon QTZ” and “Cocon QFC”:**

PN 16, –10 °C up to +120 °C

Control range 0.15 – 4 bar

Adjustable nominal control range  
30 – 120.000 l/h

**“Cocon QTZ”** DN 10 – DN 32

Inlet port: Coupling

Outlet port: Female thread

The pressure independent control valve can be equipped with an actuator, temperature controller or manual head (connection thread M 30 x 1.5). Body and bonnet made of dezincification resistant brass, seals made of EPDM or PTFE, valve stem made of stainless steel.

**“Cocon QFC”** DN 40 – DN 150

Connections:

both ports flanged according to DIN EN 1092-2; lengths according to DIN EN 558-1, basic series 1

The pressure independent control valve can be equipped with an actuator. Steady control 0 – 10 V and free choice of type of characteristic line.

Body made of cast iron (EN-GJL-250 according to DIN EN 1561), bronze bonnet, seals made of EPDM, valve stem made of dezincification resistant brass.

Advantages:

- installation in supply or return pipe
- nominal value lockable and lead sealable
- the set nominal value can be read off even with the actuator in place
- the nominal values in m<sup>3</sup>/h can be set directly without conversion
- activation through actuator

1



2



1

**1** The Oventrop pressure independent control valve "Cocon QTZ" is a valve combination consisting of an automatic regulator (nominal value manually adjustable) and a regulating valve. The pressure independent control valve can be equipped with an actuator, temperature controller or manual head (connection thread M 30 x 1.5).

The valve is used for the automatic hydronic balancing and temperature control of appliances or sections of the system in chilled ceiling, fan coil, convector, central heating and surface heating systems.

The valve is made of dezincification resistant brass and the seals of EPDM or PTFE. The valve stem is made of stainless steel.

Models:

- DN 15 up to DN 32
- with or without pressure test points
- inlet port: coupling, outlet port: female thread or inlet and outlet port: female thread

**2** The desired flow rate is set at the handwheel (pos. 4). The nominal setting is protected against unauthorized tampering with the help of the handwheel which engages automatically. This setting can be additionally secured by inserting the locking ring. During low demand periods, regulation can be carried out with the help of an actuator or temperature controller which can be screwed onto the valve.

The illustrated section of the "Cocon QTZ" pressure independent control valve shows three pressure ranges.

"p1" is the inlet and "p3" the outlet pressure of the valve. "p2" is the pressure actuating the diaphragm unit and maintaining the differential pressure "p2"-"p3" at a constant level.

**3** The pressure independent control valve "Cocon QTZ" has a linear characteristic line which is advantageous when using actuators (electrothermal or electromotive) which also have a linear stroke behaviour. In general, the valve may also be combined with a temperature controller.

Advantages:

- constant, high valve authority
- reduced dimensions
- even with the actuator in place, the required nominal values can be set
- the set nominal value can be read off even with the actuator in place
- excellent optical display of the set values in any installation position
- the nominal values in l/h can be set directly without conversion. The nominal value range of the valve is imprinted on the handwheel in a prominent position.
- the locking ring can be lead sealed to secure the setting from unauthorised access
- the pump setting can be optimised with the help of a flow-meter (e.g. "OV-DMC 2") which is connected to the pressure test points of the valve. For this purpose, the pump head is reduced until the pressure independent control valves "Cocon QTZ" are just working within the control range

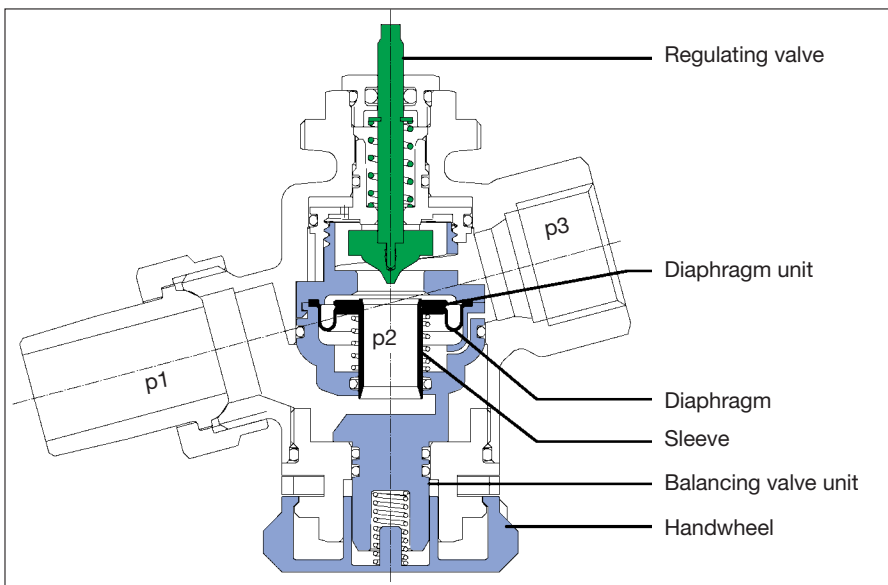

2

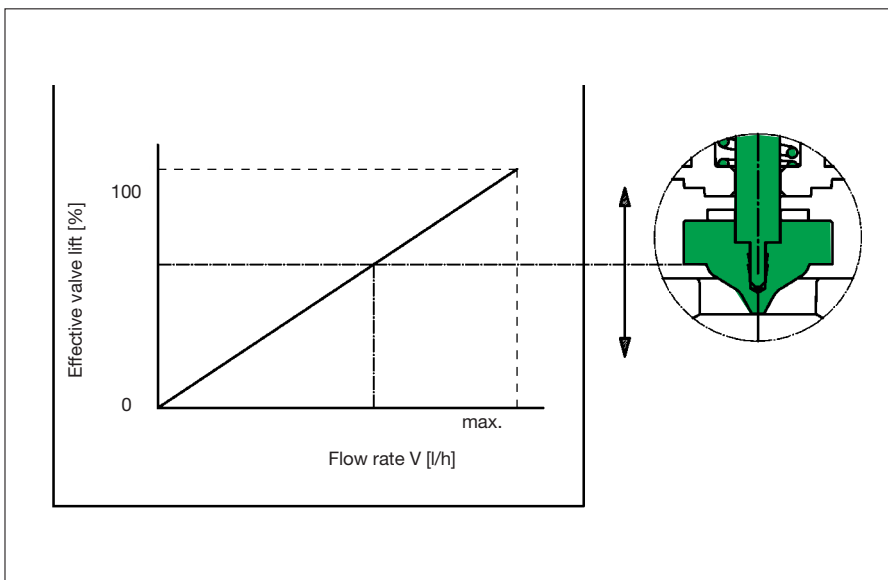

3



### 1 Regulating valve "Cocon 2TZ" for chilled and radiant ceilings (illustr. with measuring technique "classic")

The calculated flow rate for a given differential pressure is set at the regulating valve "Cocon 2TZ". Moreover, it serves to regulate the room temperature with the help of an electrothermal or electromotive actuator by an adapted linear characteristic line (not for  $kv_S = 1.8$  and  $4.5$ ).

The valve is installed in heating and cooling systems and is especially suitable for the installation in the return pipe of chilled ceiling modules. The flow rate is determined by measuring the differential pressure via the integrated metering station by use of the flow-meter "OV-DMC 2". The flow rate to be regulated can be read off the flow-meter. To carry out the hydronic balance, a flow rate deviation can immediately be readjusted by modification of the adjustment screw.

When actuating the presetting screw, the flow rate to be regulated can be read off the flow-meter if connected to the pressure test points of the regulating valve "Cocon 2TZ". For isolation, the setting screw can be completely screwed in. When opening until stop, the value of presetting is restored.

Four different models of the regulating valve "Cocon" are available:

- size  $\frac{1}{2}$ ",  $kv_{value} = 0.45$
- size  $\frac{1}{2}$ ",  $kv_{value} = 1.0$
- size  $\frac{1}{2}$ ",  $kv_{value} = 1.8$
- size  $\frac{3}{4}$ ",  $kv_{value} = 4.5$

#### General information:

To guarantee a permanent functional efficiency of the regulation and control components as well as a permanent availability of the complete cooling system, preparatory measures should be taken for the protection of the system.

On the one hand, these measures are related to possible damages caused by corrosion, especially in installations with pairings of system components of different materials (copper, steel and plastic) and on the other hand to the choice and settings of the control parameters (e. g. avoiding of energy losses in combined heating/cooling systems).

### 2 Flow rate depending on the piston stroke of the valve

The chart shows the linear characteristic lines of the regulating valves "Cocon 2TZ" size  $\frac{1}{2}$ ",  $kv_S = 0.45$ ,  $1.0$  and  $1.8$  and size  $\frac{3}{4}$ ",  $kv_S = 4.5$ .

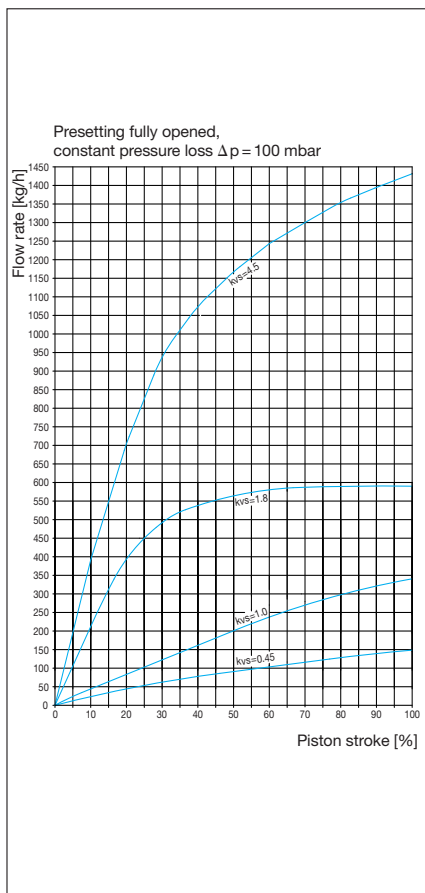

2



3

### 3 Regulating valves "Cocon 2TZ" for chilled and radiant ceilings (illustr. with measuring technique "eco")

Due to the connection thread  $M 30 \times 1.5$  the valve can be used in combination with:

- Oventrop electrothermal actuators with two point control
- Oventrop electrothermal actuators (0-10 V)
- Oventrop electromotive actuators as proportional (0-10 V) or three point control
- Oventrop electromotive actuators EIB or LON<sup>®</sup>



4

### 4 Measuring device for a quick regulation of the "Cocon 2TZ" valves with measuring technique "eco".



1



2



3

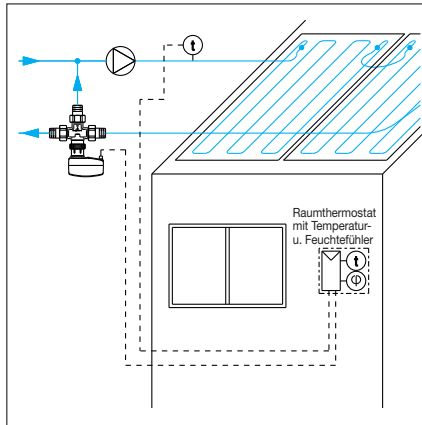

4



5



6



7

**1** Three-way diverting valve "Tri-D TB", brass  
valve DN 15 with connection thread M 30 x 1.5 for use in heating and cooling systems, 3 x 3/4" male threaded connection "Euro" cone for different pipes:

- threaded tailpipe
- solder tailpipe
- plug-in tailpipe
- compression fittings for copper, plastic and composition pipes

The valve is installed in the return pipe of chilled ceilings for the regulation of the flow temperature depending on the dew point temperature of the room. Adaptation of the flow temperature of the chilled ceiling without interrupting cooling operation. The installation not only of a temperature sensor in the supply pipe of the chilled ceiling but also of a sensor detecting the humidity of the room is required.

**2** Three-way diverting valve "Tri-D plus TB" with T-piece DN 15 with connection thread M 30 x 1.5 for thermostats and actuators. Male threaded connection 4 x 3/4" to the pipe for different tailpipes and compression fittings.

Application:

- chilled ceilings
- Fan-Coil units
- heating systems
- for mass flow distribution with additional possibility for room temperature control or dew point control e. g.

**3** Three-way diverting valve "Tri-D TR", bronze

Three-way mixing valve "Tri-M TR", bronze  
Flat sealing valves sized DN 20, 25, 40 with connection thread M 30 x 1.5 for thermostats or actuators. The valves are used in heating or cooling systems in which the volumes of flow are to be diverted, mixed or changed-over. They are frequently used for storage charging connections or in heating systems with two heat producers.

**4** System illustration

Three-way diverting valve in a chilled ceiling e. g. with electromotive actuator with temperature sensor in the supply pipe.

**5** Four-port mixing valve "Tri-M plus TR", brass  
Regulating valve for heating and cooling systems as well as for the regulation of suspended and vertical Fan-Coil units.

Valve DN 15 with connection thread M 30 x 1.5 for thermostats and actuators. Flat sealing male threaded connection 4 x 1/2".

Technical data:

Max. operating pressure: 10 bar

Max. differential pressure: 1 bar

Operating temperature range:

-10 °C to +120 °C

kvs values: 0.45/1.0/1.8

**6** "Series KT"

Valves for the regulation of Fan-Coil units and induction-coil appliances. Oventrop thermostatic radiator valves for use in chilled water circuits are proportional regulators working without auxiliary energy. The room temperature is regulated by varying the chilled water flow. The valve opens with the temperature at the sensor rising. Angle and straight pattern valves: DN 15 to DN 25

**7** Thermostats

The thermostats with remote control "Uni FH" or the Oventrop remote control with additional remote sensor (see system illustration, illustr. 7 and 8) are used as regulators.



1



2



3



4

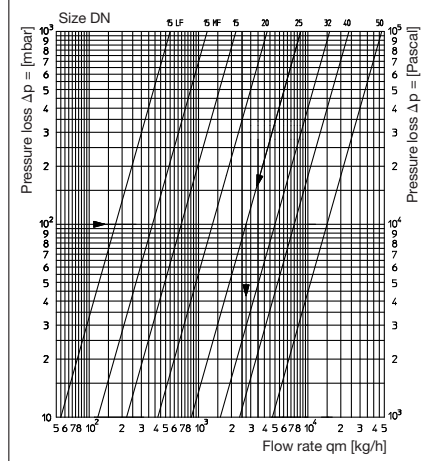
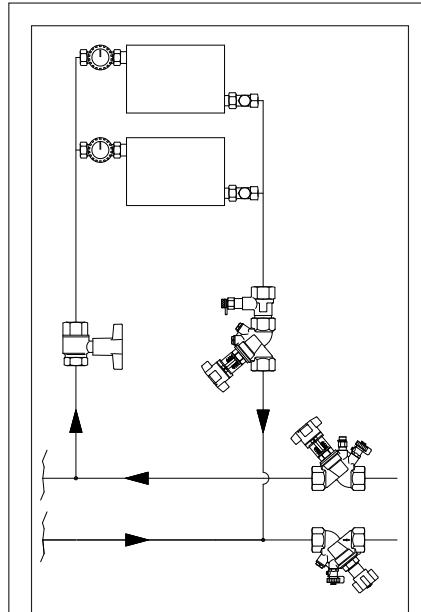

### Design example

Required: Flow value at the metering station

Given: Differential pressure via the metering station = 100 mbar  
Size DN 25

Solution: Flow value = 2750 kg/h  
(taken from chart for bronze metering station)



5

The measurement of the flow values and the hydronic regulation of parts of the system may also be carried out with the help of the metering stations. They are installed in the direction of flow in front of the "Hycocou", "Hydrocontrol" or "Hydromat".

Unlike the measuring technique at the double regulating and commissioning valves ("Hydrocontrol"), the pressure differences for the registration of the flow values are measured at invariable flow cross sections.

The metering stations use the same test point connection system as the "Hydrocontrol" valves.

When using the Oventrop flow-meter "OV-DMC 2", in which the flow characteristic lines of the metering stations are stored, the simultaneous indication of the flow value on the display is possible when modifying the throttle cross section at the valve.

Flow values for Oventrop metering stations at 1 bar differential pressure are indicated on page 13.

**1** Commissioning set "Hydroset" PN 25  
Double regulating and commissioning valve with metering station made of dezincification resistant brass  
Sizes: DN 15 – DN 50

**2** "Hydrocontrol MTR" PN 25  
Double regulating and commissioning valve with integrated metering station (measuring technique "classic") for the hydronic balancing of heating and cooling systems, with reproducible presetting. Quick regulation of the valve. Steady and direct flow indication during the regulation. Pressure test points and handwheel on the same level.  
Sizes: DN 15 – DN 50

**3** Stainless steel or cast iron metering station for installation between flanges  
Sizes: DN 65 – DN 1000

**4** Commissioning set "Hydroset F"  
Double regulating and commissioning valve with metering station

**5** Butterfly valves  
With metering station for installation between flanges  
Sizes: DN 32 – DN 400



1



2



3



4



5



6



7



8

**1** Electrothermal actuators with connection thread M 30 x 1.5 for room temperature control combined with two point controls, connection cable 1 m long.

Models:

- closed with current off 230 V
- opened with current off 230 V
- closed with current off 24 V
- opened with current off 24 V
- closed with current off 230 V with auxiliary switch
- 0-10 V

**2** Electromotive actuators with connection thread M 30 x 1.5 for room temperature control combined with proportional (0-10 V) two or three point controls. Installation in radiant and chilled ceiling systems as well as induction coil appliances.

Models:

- 24 V proportional actuator (0-10 V), with anti-blocking function
- 230 V three point actuator, without anti-blocking function
- 24 V three point actuator, without anti-blocking function
- 230 V two point actuator, without anti-blocking function

**3** Electromotive actuators with connection thread M 30 x 1.5 systems EIB, LON<sup>®</sup> with integrated bus coupling.

The electromotive actuators are suitable for a direct connection to the European Installation Bus control system and the LONWORKS<sup>®</sup> networks. The power absorption is extremely low, so that a separate power supply is not needed.

**4** Room thermostat 24 V/230 V, digital, with fan drive.

**5** Room thermostat 230 V with fan drive.

**6** Room thermostat - clock 230 V and room thermostat 230 V and 24 V

Room temperature control and timed temperature setback by use of the room thermostat-clock or the room thermostat (via an external time switch) in combination with electrothermal actuators.

**7** Electronic room thermostat 24 V required when combined with an electromotive, proportional actuator for individual room temperature control. With one analogue outlet 0-10 V each for heating and cooling as well as adjustable neutral zone (0.5-7.5K).

**8** Dew point control 24 V required in combination with room thermostats to protect the chilled ceilings against condensation.



1. Oventrop valves and actuators: see table  
 2. Oventrop valves with actuators of other manufacturers: With due consideration of the valve parameters, the combination with actuators of other manufacturers is possible on consultation.  
 h = valve  
 x = lower stroke of the valve  
 3. Oventrop actuators with valves of other manufacturers: on consultation  
 4. Integration into the centralised building control system (CBC): The four most important characteristic parameters are shown in the table.

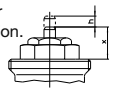











① NC = closed with current "off"      NO = open with current "off"  
 EM = electromotive                      ET = electrothermal  
 ② Operating behaviour: additionally 4–20 mA / 2–10 V  
 ③ Valve adapter "Hycoco" (item no. 1012992) required.  
 ④  $K_{VS}$ -value can be reduced  
 ⑤ Piston stroke  $\geq$  effective valve lift  
 ⑥ Valve adapter 1012462 required.

| Illustration (examples)                    | Ratings actuators |             | Characteristic parameters for CBC |                     |  |                          |                    |                      |                | Valve characteristic line | Actuator characteristic line |            |                             |  |  |  |  |  |  |  |
|--|-------------------|-------------|-----------------------------------|---------------------|--|--------------------------|--------------------|----------------------|----------------|---------------------------|------------------------------|------------|-----------------------------|--|--|--|--|--|--|--|
|  | Item no.          | Model       | Operating current                 | Operating behaviour | Interface                                  | Upper lift position [mm] | Piston stroke [mm] | Operating power [mm] | Medium bearing |                           |                              | Protection | Max. fluid temperature [°C] |  |  |  |  |  |  |  |
| A<br>"Aktor T 2P L NC" / "Aktor T 2P H NC" | 10124...          | ET NC       | 24 V / 230 V                      | 2 point             | digital                                    | 11.2                     | 15.8               | -                    | -              | IP54                      | +100                         |            |                             |  |  |  |  |  |  |  |
| B<br>"Aktor T 2P L NO" / "Aktor T 2P H NO" | 10124...          | ET NO       | 24 V / 230 V                      | 2 point             | digital                                    | 11.2                     | 15.8               | > 90                 | > 90           | IP54                      | +100                         |            |                             |  |  |  |  |  |  |  |
| C<br>"Aktor T ST L NC"                     | 1012953           | ET NC       | 24 V                              | steady (0–10 V)     | analogue                                   | 11.2                     | 15.8               | > 90                 | > 90           | IP54                      | +100                         |            |                             |  |  |  |  |  |  |  |
| D<br>"Aktor M ST L"                        | 1012705           | EM          | 24 V                              | steady (0–10 V)     | analogue                                   | 11.2                     | 15.8               | 0.5–4.0              | > 90           | IP40                      | +100                         |            |                             |  |  |  |  |  |  |  |
| E<br>"Aktor M ST L"                        | 1012706           | EM          | 24 V                              | steady (0–10 V)     | analogue                                   | 11.2                     | 15.8               | 0.5–4.0              | > 90           | IP40                      | +100                         |            |                             |  |  |  |  |  |  |  |
| F<br>"Aktor M 3P L"                        | 1012708           | EM          | 24 V                              | 3 point             | digital                                    | 11.2                     | 15.8               | > 90                 | > 90           | IP40                      | +100                         |            |                             |  |  |  |  |  |  |  |
| G<br>"Aktor M 3P H"                        | 1012709           | EM          | 230 V                             | 3 point             | digital                                    | 11.2                     | 15.8               | > 90                 | > 90           | IP40                      | +100                         |            |                             |  |  |  |  |  |  |  |
| H<br>"Aktor M 2P H" / "Aktor M 2P L"       | 1012710/11        | EM NO       | 230 V / 24 V                      | 2 point             | digital                                    | 11.2                     | 17.0               | > 90                 | > 90           | IP54                      | +100                         |            |                             |  |  |  |  |  |  |  |
| I<br>"Aktor M ST EIB"                      | 11560...          | EM          | 24 V                              | steady              | EIB / KNX                                  | 11.2                     | 15.2               | 2.6–4.0              | > 90           | IP44                      | +100                         |            |                             |  |  |  |  |  |  |  |
| J<br>"Aktor M ST LON"                      | 1157065           | EM          | nom. 48 V                         | steady              | LON  | 11.2                     | 15.2               | 2.6–4.0              | > 90           | IP44                      | +100                         |            |                             |  |  |  |  |  |  |  |
| K<br>"Aktor MH CON B"                      | 1150665           | Mignon (2x) | EM                                | steady              | ErOcean (EEP-A5-30-1i) Or wireless ErOcean | 11.0                     | 15.4               | 2                    | > 90           | IP20                      | +90                          |            |                             |  |  |  |  |  |  |  |
| L<br>"Aktor MH ENO B"                      | 1150765           | Mignon (2x) | EM                                | steady              | ErOcean (EEP-A5-30-1i) Or wireless ErOcean | 11.0                     | 15.4               | 2                    | > 90           | IP20                      | +90                          |            |                             |  |  |  |  |  |  |  |

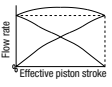
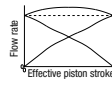
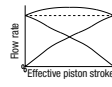
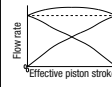
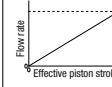
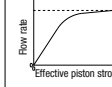
In vertical to horizontal position, not suspended

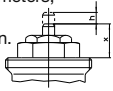
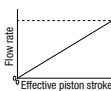
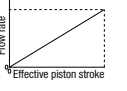
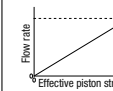
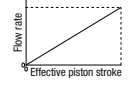
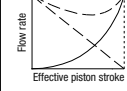
All values are standard values without tolerances

| 5   | 6   | 7   | 8   | 9   | 10  |
|---|---|---|---|---|---|
|  |  |  |  |  |  |
| "Tri-M plus TR"   | "Tri-D plus TB"   | "Tri-DTR/Tri-MTR"   | "Tri CTR"   | Two-way straight pattern valve  | "Series KTB"  |
| 11427..   | 11426..   | 11302/11307   | 11312   | 11307..   | 11417-11419   |
| 15  | 15  | 20/25/40  | 15-50   | 20/25/40  | 15/20/25  |
| M 30 x 1.5  | M 30 x 1.5  | M 30 x 1.5  | M 30 x 1.5  | M 30 x 1.5  | M 30 x 1.5  |
| 11.8  | 11.8  | 11.8  | 11.8  | 11.8  | 12.8  |
| 1   | 1   | 0.75/0.5/0.2  |   | 0.75/0.5/0.2  | 0.5   |
| 2.5   | 2.5   | 2.8   | 2.8   | 3   | 2.5   |
| 10  | 16  | 16  | 16  | 16  | 10  |
| 14.3 or higher  | 14.3 or higher  | 14.6 or higher  | 14.6 or higher  | 14.8 or higher  | 13.3 or higher  |
| 11.3 or lower   | 11.3 or lower   | 11.3 or lower   | 11.3 or lower   | 11.3 or lower   | 10.8 or lower   |
| 90 / 150  | 90 / 150  | 90 / 150  | 90 / 150  | 90 / 150  | 90 / 150  |
|  |  |  |  |  |  |
| •   | •   | •   | •   | •   |   |
| •   | •   | •   | •   | •   | • <sup>④</sup>  |
| • <sup>⑤</sup>  | • <sup>⑤</sup>  | • <sup>⑤</sup>  | • <sup>⑤</sup>  | • <sup>⑤</sup>  |   |
| •   | •   | •   | •   | •   |   |
| •   | •   | •   | •   | •   |   |
| •   | •   | •   | •   | •   |   |
| •   | •   | •   | •   | •   |   |
| •   | •   | •   | •   | •   | • <sup>④</sup>  |
| •   | •   | •   | •   | •   |   |
| •   | •   | •   | •   | •   |   |
|   |   |   |   |   |   |
|   |   |   |   |   |   |

|   |  |  |  |  |  |   |   |
|---|--|--|--|--|--|---|---|
| <p>1. Oventrop valves and actuators: see table</p> <p>2. Oventrop valves with actuators of other manufacturers: With due consideration of the valve parameters, the combination with actuators of other manufacturers is possible on consultation.<br/>h = valve<br/>x = lower stroke of the valve</p> <p>3. Oventrop actuators with valves of other manufacturers: on consultation</p> <p>4. Integration into the centralised building control system (CBC): The four most important characteristic parameters are shown in the table.</p> |  |  |  |   |  |   |   |
| <p>① NC = closed with current "off"    NO = open with current "off"<br/>EM = electromotive    ET = electrothermal</p> <p>② Operating behaviour: additionally 4–20 mA / 2–10 V</p> <p>③ Valve adapter "Hycoco" (item no. 1012992) required.</p> <p>④ <math>k_{VS}</math>-value can be reduced</p> <p>⑤ Piston stroke <math>\geq</math> effective valve lift</p>  |  |  |  |  |  |   |   |
| <p>Illustration (examples)</p>  |  |  |  | 1  | 2  | 3   | 4   |
| Ratings valve   |  |  |  | "Cocon QTR"  | "Cocon QFC"  | "Cocon QFC/QGC"   | Two-way valve   |
| Item no.  |  |  |  | 11461..  | 1146149/50   | 1146151-55/1676251-53   | 11308../16708..   |
| DN  |  |  |  | 40/50  | 40/50  | 65/80/100/125/150/200   | 15-150  |
| Connection  |  |  |  | Squeeze connection   | Squeeze connection   | Squeeze connection  | Squeeze connection  |
| Closing dimension x [mm]  |  |  |  |  |  |   |   |
| $\Delta p$ max [bar]  |  |  |  | 4  | 4  | 4   | 0.7-12.1  |
| Valve lift h [mm]   |  |  |  | 10   | 10   | 20 / 36 / 40  | 10 / 30 / 40  |
| PN  |  |  |  | 16   | 16   | 16  | 16  |
| Demands on actuators  |  |  |  |  |  |   |   |
| Upper lift position [mm]  |  |  |  |  |  |   |   |
| Lower lift position [mm]  |  |  |  |  |  |   |   |
| Closing pressure [N] min/max  |  |  |  | 500  | 500  | 2000  |   |
| Valve characteristic line   |  |  |  |   |  |  |  |
| Actuator characteristic line  |  |  |  |   |  |  |  |
| Illustration (examples)   |  |  |  | A  | B  | C   | D   |
| "Aktor M ST L"  |  |  |  |  |  |   |   |
| Item no.  |  |  |  | 1158010  | 1158011  | 1158030   | 1158031   |
| Model   |  |  |  | EM   | EM   | EM  | EM  |
| Operating current   |  |  |  |  |  |   |   |
| Operating behaviour   |  |  |  |  |  |   |   |
| Interface   |  |  |  |  |  |   |   |
| Lower lift position [mm]  |  |  |  | 72.5   | 72.5   | 72.5  | 72.5  |
| Upper lift position [mm]  |  |  |  | 82.5   | 82.5   | 112.5   | 112.5   |
| Piston stroke [mm]  |  |  |  | 10   | 10   | 40  | 40  |
| Operating power [mm]  |  |  |  | 500  | 500  | 2500  | 2000  |
| Operating power [mm]  |  |  |  | 7.5 s/mm   | 7.5 s/mm   | 2 s/mm  | 2 s/mm  |
| Medium floating   |  |  |  | IP54   | IP54   | IP66  | IP66  |
| Protection  |  |  |  |  |  |   |   |
| Max. fluid temperature [°C]   |  |  |  | +120   | +120   | +120  | +120  |
| Permissible install. position   |  |  |  |  |  |   |   |
| In vertical to horizontal position, not suspended   |  |  |  |  |  |   |   |
| Adjustable at the actuators   |  |  |  | •  | •  | •   | •   |
| Adjustable at the actuators   |  |  |  |  |  |   | •   |
| Adjustable at the actuators   |  |  |  |  |  | •   | •   |
| Adjustable at the actuators   |  |  |  |  |  | •   | •   |
| Adjustable at the actuators   |  |  |  |  |  | •   | •   |
| Piston stroke   |  |  |  | •  | •  | •   |   |
| Drive   |  |  |  |  |  | DN 65-100   |   |
| Piston stroke   |  |  |  | •  | •  | •   |   |
| Drive   |  |  |  |  |  | DN 65-100   |   |
| Piston stroke   |  |  |  | •  | •  | •   |   |
| Drive   |  |  |  |  |  | DN 65-100   |   |
| "Aktor M ST L"  |  |  |  |  |  |   |   |
| Item no.  |  |  |  | 1158020  |  |   |   |
| Model   |  |  |  | EM   |  |   |   |
| Operating current   |  |  |  |  |  |   |   |
| Operating behaviour   |  |  |  |  |  |   |   |
| Interface   |  |  |  |  |  |   |   |
| Lower lift position [mm]  |  |  |  |  |  |   |   |
| Upper lift position [mm]  |  |  |  |  |  |   |   |
| Piston stroke [mm]  |  |  |  | 20   |  |   |   |
| Operating power [mm]  |  |  |  | 850  |  |   |   |
| Operating power [mm]  |  |  |  | 9 s/mm   |  |   |   |
| Medium floating   |  |  |  | IP54   |  |   |   |
| Protection  |  |  |  |  |  |   |   |
| Max. fluid temperature [°C]   |  |  |  | +120   |  |   |   |
| Permissible install. position   |  |  |  |  |  |   |   |
| Adjustable at the actuators   |  |  |  | •  | •  | •   |   |
| Adjustable at the actuators   |  |  |  |  |  |   |   |
| Adjustable at the actuators   |  |  |  |  |  |   |   |
| Adjustable at the actuators   |  |  |  |  |  |   |   |
| Adjustable at the actuators   |  |  |  |  |  |   |   |
| Piston stroke   |  |  |  | •  | •  | •   |   |
| Drive   |  |  |  |  |  | DN 65-100   |   |

All values are standard values without tolerances



1

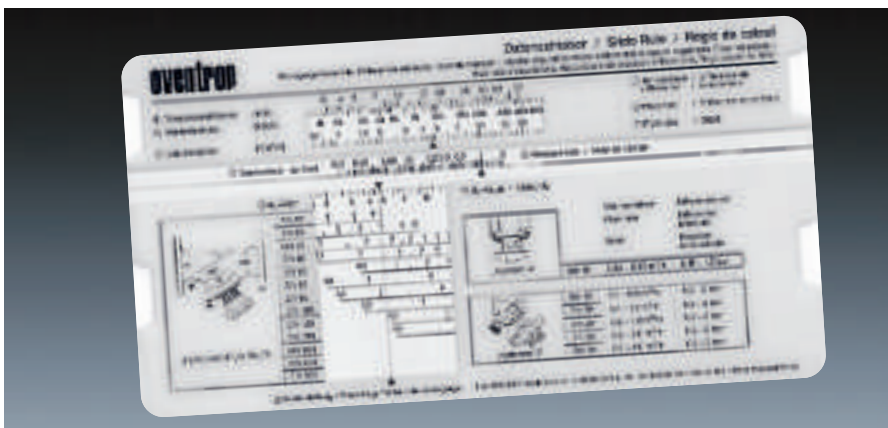

2

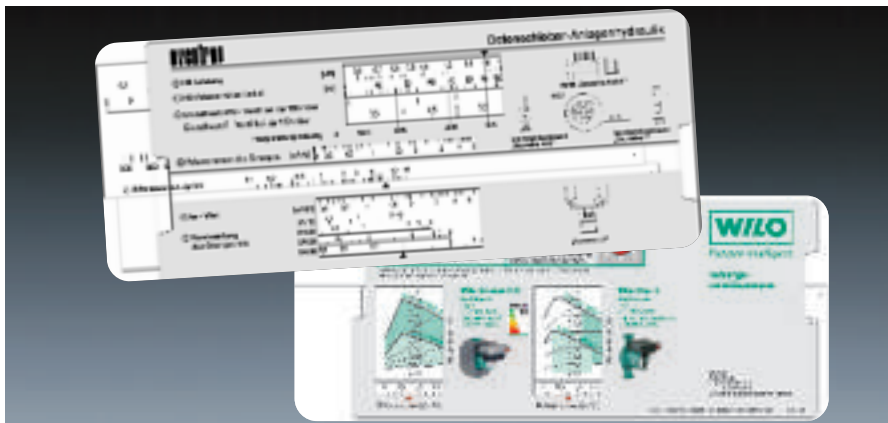

3

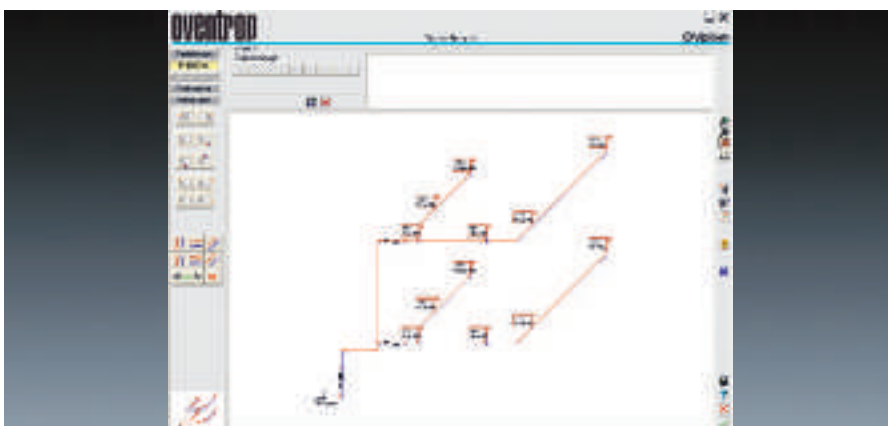

4

Oventrop supports its partners regarding planning, completion and regulation of hydronic systems. Current information material like catalogues, technical data sheets, system illustrations and colour leaflets as well as DVDs, calculation slides and software are available.

**1** Apart from general information on the Oventrop products for hydronic balancing, the Oventrop DVD includes data sets, valve illustrations etc.

**2** Oventrop calculation slides for a rapid design of double regulating and commis-sioning valves, differential pressure and flow regulators for hydronic balancing.

**3** Oventrop/WILO calculation slide for a rapid design of hydronic systems.

**4** Internet address [www.oventrop.de](http://www.oventrop.de) with calculation programmes like OVplan or OVselect.

Further information can be found in the Oventrop catalogue "Products", in the technical data sheets as well as on the internet, product ranges 3 and 5.

Subject to technical modification without notice.

OVENTROP GmbH & Co. KG  
Paul-Oventrop-Straße 1  
D-59939 Olsberg  
Germany  
Telephone +49 (0) 29 62 82-0  
Telefax +49 (0) 29 62 82-450  
E-Mail [mail@oventrop.de](mailto:mail@oventrop.de)  
Internet [www.oventrop.com](http://www.oventrop.com)

For an overview of our global presence visit [www.oventrop.de](http://www.oventrop.de)